

Report on Inverse

Generated by MTT using :
(mtt -u -q -q Inverse rep pdf)

Tue Aug 19 15:04:36 BST 2003

Contents

I	Inverse	7
1	iMacroMicro	9
1.1	iMacroMicro_abg.tex	9
	1.1.1 Summary information	10
	1.1.2 Subsystems	11
1.2	iMacroMicro_cbg.ps	11
1.3	iMacroMicro_struct.tex	12
1.4	iMacroMicro_dae.tex	12
1.5	iMacroMicro_dm.tex	13
1.6	iMacroMicro_tf.tex	14
1.7	iMacroMicro_numpar.txt	15
1.8	iMacroMicro_lmfr.ps	15
1.9	iMacroMicro_lpfr.ps	15
1.10	iMacroMicro_sro.ps	15
1.11	iMacroMicro_odeso.ps	17
II	iNMP	19
2	NMP	21
2.1	NMP_abg.tex	21
	2.1.1 Summary information	22
	2.1.2 Subsystems	24
2.2	NMP_struct.tex	24
2.3	NMP_ode.tex	24
2.4	NMP_sm.tex	25
2.5	NMP_tf.tex	25
2.6	NMP_sro.ps	25
2.7	NMP_lmfr.ps	27
2.8	NMP_lpfr.ps	27

3	iNMP	29
3.1	iNMP_abg.tex	29
	3.1.1 Summary information	30
	3.1.2 Subsystems	32
3.2	iNMP_struct.tex	32
3.3	iNMP_ode.tex	32
3.4	iNMP_dm.tex	33
3.5	iNMP_tf.tex	34
3.6	iNMP_lmfr.ps	34
3.7	iNMP_lpfr.ps	34
III	iRC2	37
4	iRC2c	39
4.1	iRC2c_abg.tex	39
	4.1.1 Summary information	39
	4.1.2 Subsystems	41
4.2	iRC2c_struct.tex	41
4.3	iRC2c_dae.tex	41
4.4	iRC2c_dm.tex	42
4.5	iRC2c_tf.tex	42
5	iRC2n	43
5.1	iRC2n_abg.tex	43
	5.1.1 Summary information	43
	5.1.2 Subsystems	45
5.2	iRC2n_struct.tex	45
5.3	iRC2n_dae.tex	45
5.4	iRC2n_dm.tex	46
5.5	iRC2n_tf.tex	46
6	saRC2c	47
6.1	saRC2c_abg.tex	47
	6.1.1 Summary information	48
	6.1.2 Subsystems	49
6.2	saRC2c_struct.tex	49
6.3	saRC2c_dae.tex	50
6.4	saRC2c_dm.tex	50
6.5	saRC2c_tf.tex	51
6.6	saRC2c_odeso.ps	51

CONTENTS	5
----------	---

6.7	saRC2c_lmfr.ps	51
7	szRC2c	53
7.1	szRC2c_abg.tex	53
7.1.1	Summary information	54
7.1.2	Subsystems	55
7.2	szRC2c_struct.tex	55
7.3	szRC2c_dae.tex	56
7.4	szRC2c_dm.tex	57
7.5	szRC2c_tf.tex	57
7.6	zRC2c_odeso.ps	58
7.7	szRC2c_lmfr.ps	58
8	szRC2n	61
8.1	szRC2n_abg.tex	61
8.1.1	Summary information	62
8.1.2	Subsystems	63
8.2	szRC2n_struct.tex	63
8.3	szRC2n_dae.tex	64
8.4	szRC2n_dm.tex	65
8.5	szRC2n_tf.tex	66
8.6	szRC2n_odeso.ps	66
8.7	szRC2n_lmfr.ps	66
IV	Inverse	69
9	iTanks	71
9.1	iTanks_abg.tex	71
9.1.1	Summary information	72
9.1.2	Subsystems	73
9.2	iTanks_cbg.ps	74
9.3	iTanks_struct.tex	74
9.4	iTanks_dm.tex	75
9.5	iTanks_tf.tex	76
9.6	iTanks_lmfr.ps	76
9.7	iTanks_lpfr.ps	76
10	iTwoLink	79
10.1	iTwoLink_abg.tex	79
10.1.1	Summary information	80

10.1.2	Subsystems	82
10.1.3	INTF	82
10.1.4	ROD	84
10.1.5	msd	87
10.1.6	twolink	89
10.2	iTwoLink_struct.tex	92
10.3	iTwoLink_simp.r	94
10.4	iTwoLink_dae.tex	94
10.5	iTwoLink_ode.tex	95
10.6	iTwoLink_sspar.r	96
10.7	iTwoLink_sm.tex	96
10.8	iTwoLink_tf.tex	97
10.9	iTwoLink_numpar.txt	98
10.10	iTwoLink_input.txt	98
10.11	iTwoLink_odeso.ps (<i>-iTwoLink_t1</i>)	99
10.12	iTwoLink_odeso.ps (<i>-iTwoLink_t2</i>)	100
10.13	iTwoLink_odeso.ps (<i>-iTwoLink_t1s</i>)	100
10.14	iTwoLink_odeso.ps (<i>-iTwoLink_t1s:iTwoLink_t1</i>)	100
10.15	iTwoLink_odeso.ps (<i>-iTwoLink_t2s:iTwoLink_t2</i>)	102

List of Figures

1.1	System iMacroMicro : acausal bond graph	9
1.2	System iMacroMicro , representation cbg (-noargs)	11
1.3	System iMacroMicro , representation lmfr (-noargs)	16
1.4	System iMacroMicro , representation lpfr (-noargs)	16
1.5	System iMacroMicro , representation sro (-noargs)	17
1.6	System iMacroMicro , representation odeso (-noargs)	18
2.1	System NMP : acausal bond graph	21
2.2	System NMP , representation sro (-noargs)	26
2.3	System NMP , representation lmfr (-noargs)	26
2.4	System NMP , representation lpfr (-noargs)	27
3.1	System iNMP : acausal bond graph	29
3.2	System iNMP , representation lmfr (-noargs)	34
3.3	System iNMP , representation lpfr (-noargs)	35
4.1	System iRC2c : acausal bond graph	39
5.1	System iRC2n : acausal bond graph	43
6.1	System saRC2c : acausal bond graph	47
6.2	System saRC2c , representation odeso (-noargs)	52
6.3	System saRC2c , representation lmfr (-noargs)	52
7.1	System szRC2c : acausal bond graph	53
7.2	System zRC2c , representation odeso (-noargs)	58
7.3	System szRC2c , representation lmfr (-noargs)	59
8.1	System szRC2n : acausal bond graph	61
8.2	System szRC2n , representation odeso (-noargs)	66
8.3	System szRC2n , representation lmfr (-noargs)	67
9.1	System iTanks : acausal bond graph	71

9.2	System iTanks , representation cbg (-noargs)	74
9.3	System iTanks , representation lmfr (-noargs)	77
9.4	System iTanks , representation lpfr (-noargs)	78
10.1	System iTwoLink : acausal bond graph	79
10.2	System INTF : acausal bond graph	82
10.3	System ROD : acausal bond graph	84
10.4	System msd : acausal bond graph	87
10.5	System twolink : acausal bond graph	90
10.6	System iTwoLink , representation odeso ($-iTwoLink_{t_1}$)	99
10.7	System iTwoLink , representation odeso ($-iTwoLink_{t_2}$)	100
10.8	System iTwoLink , representation odeso ($-iTwoLink_{t_{1s}}$)	101
10.9	System iTwoLink , representation odeso ($-iTwoLink_{t_{1s}:iTwoLink_{t_1}}$)	101
10.10	System iTwoLink , representation odeso ($-iTwoLink_{t_{2s}:iTwoLink_{t_2}}$)	102

Part I
Inverse

Chapter 1

iMacroMicro

1.1 iMacroMicro_abg.tex

MTT command:

```
mtt iMacroMicro abg tex
```

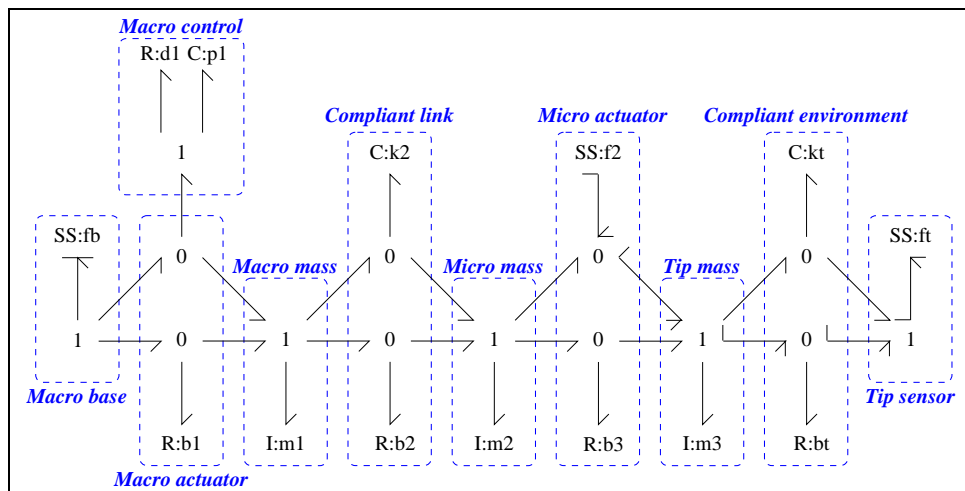

Figure 1.1: System **iMacroMicro**: acausal bond graph

The acausal bond graph of system **iMacroMicro** is displayed in Figure 1.1 (on page 9) and its label file is listed in Section 1.1.1 (on page 10). The subsystems are listed in Section 1.1.2 (on page 11).

This is a Bond Graph model of the macro-micro manipulation system discussed by Sharon in his thesis and by Sharon, Hogan and Hardt in various papers.

The micro loop is inverted whilst leaving the macro control in place. This *partial inverse* gives information about the *zero dynamics* of the micro control system with the particular macro controller in place and allows design of the macro controller to ease the design of the micro controller.

1.1.1 Summary information

Interface information:

This component has no ALIAS declarations

Variable declarations:

This component has no PAR declarations

Units declarations:

This component has no UNITS declarations

The label file: iMacroMicro.lbl.txt

```
%% Label file (macmic_lbl.txt)
%% Each line should be of one of the following forms:
% a comment (ie starting with %)
% Component-name CR_name arg1,arg2,..argn
% blank

%Masses
m1 lin flow,m_1
m2 lin flow,m_2
m3 lin flow,m_3

%Springs
k2 lin state,k_2
kt lin state,k_t

%Dampers
b1 lin flow,b_1
b2 lin flow,b_2
b3 lin flow,b_3
bt lin flow,b_t
```

```

%Source/sensors
f2 SS external,internal
ft SS external,0
fb SS internal,0

%Control
p1 lin flow,p_1
d1 lin flow,d_1

```

1.1.2 Subsystems

No subsystems.

1.2 iMacroMicro_cbg.ps

MTT command:

```
mtt iMacroMicro cbg ps
```

This representation is given as Figure 1.2 (on page 11).

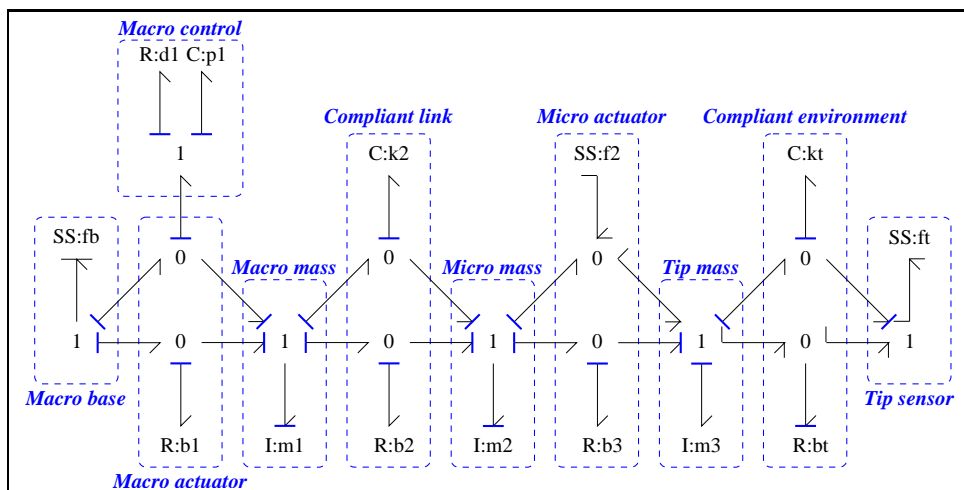

Figure 1.2: System **iMacroMicro**, representation cbg (-noargs)

1.3 iMacroMicro_struct.tex

MTT command:

```
mtt iMacroMicro struct tex
```

List of inputs for system iMacroMicro			
	Component	System	Repetition
1	ft	iMacroMicro_ft	1

List of nonstates for system iMacroMicro			
	Component	System	Repetition
1	m3	iMacroMicro_m3	1

List of outputs for system iMacroMicro			
	Component	System	Repetition
1	f2	iMacroMicro_f2	1

List of states for system iMacroMicro			
	Component	System	Repetition
1	m1	iMacroMicro_m1	1
2	m2	iMacroMicro_m2	1
3	k2	iMacroMicro_k2	1
4	kt	iMacroMicro_kt	1
5	p1	iMacroMicro_p1	1

1.4 iMacroMicro_dae.tex

MTT command:

```
mtt iMacroMicro dae tex
```

$$\begin{aligned}
\dot{x}_1 &= \frac{(-b_1 m_2 x_1 p_1 + b_2 m_1 x_2 p_1 - b_2 m_2 x_1 p_1 - d_1 m_2 x_1 p_1 - k_2 m_1 m_2 x_3 p_1 + m_1 m_2 x_5)}{(m_1 m_2 p_1)} \\
\dot{x}_2 &= \frac{(-b_2 m_1 x_2 + b_2 m_2 x_1 + k_2 m_1 m_2 x_3 - m_1 m_2 \dot{z}_1 - m_1 m_2 u_1)}{(m_1 m_2)} \\
\dot{x}_3 &= \frac{(-m_1 x_2 + m_2 x_1)}{(m_1 m_2)} \\
\dot{x}_4 &= \frac{(-k_t x_4 + u_1)}{b_t} \\
\dot{x}_5 &= \frac{(-x_1)}{m_1}
\end{aligned} \tag{1.1}$$

$$z_1 = \frac{(m_3(-k_t x_4 + u_1))}{b_t} \tag{1.2}$$

$$y_1 = \frac{(-b_3 b_t x_2 - b_3 k_t m_2 x_4 + b_3 m_2 u_1 + b_t m_2 \dot{z}_1 + b_t m_2 u_1)}{(b_t m_2)} \tag{1.3}$$

1.5 iMacroMicro_dm.tex

MTT command:

```
mtt iMacroMicro dm tex
```

$$E = \begin{pmatrix} 1 & 0 & 0 & 0 & 0 & 0 & 0 & 0 \\ 0 & 1 & 0 & 0 & 0 & 0 & 0 & 0 \\ 0 & 0 & 1 & 0 & 0 & 0 & 0 & 0 \\ 0 & 0 & 0 & 1 & 0 & 0 & 0 & 0 \\ 0 & 0 & 0 & 0 & 1 & 0 & 0 & 0 \\ 0 & 0 & 0 & 0 & 0 & 1 & 0 & 0 \\ 0 & 0 & 0 & 0 & 0 & 0 & 1 & 0 \\ 0 & 0 & 0 & 0 & 0 & 0 & 0 & 0 \end{pmatrix} \tag{1.4}$$

$$A = \begin{pmatrix} \frac{-(b_1+b_2+d_1)}{m_1} & \frac{b_2}{m_2} & -k_2 & 0 & \frac{1}{p_1} & 0 & 0 \\ \frac{b_2}{m_1} & \frac{(-b_2)}{m_2} & k_2 & 0 & 0 & 0 & -1 \\ \frac{1}{m_1} & \frac{(-1)}{m_2} & 0 & 0 & 0 & 0 & 0 \\ 0 & 0 & 0 & \frac{(-k_t)}{b_t} & 0 & 0 & 0 \\ \frac{(-1)}{m_1} & 0 & 0 & 0 & 0 & 0 & 0 \\ 0 & 0 & 0 & 0 & 0 & 0 & 1 \\ 0 & 0 & 0 & \frac{(-k_t m_3)}{b_t} & 0 & -1 & 0 \end{pmatrix} \quad (1.5)$$

$$B = \begin{pmatrix} 0 \\ -1 \\ 0 \\ \frac{1}{b_t} \\ 0 \\ 0 \\ \frac{m_3}{b_t} \end{pmatrix} \quad (1.6)$$

$$C = \left(0 \quad \frac{(-b_3)}{m_2} \quad 0 \quad \frac{(-b_3 k_t)}{b_t} \quad 0 \quad 0 \quad 1 \right) \quad (1.7)$$

$$D = \left(\frac{(b_3 + b_t)}{b_t} \right) \quad (1.8)$$

1.6 iMacroMicro_tf.tex

MTT command:

```
mtt iMacroMicro tf tex
```

$$G = \left(\frac{(b_1 b_2 b_3 p_1 s^3 + b_1 b_2 b_t p_1 s^3 + b_1 b_2 k_t p_1 s^2 + b_1 b_2 m_3 p_1 s^4 + b_1 b_3 b_t p_1 s^3 + b_1 b_3 k_2 p_1 s^2 + b_1 b_3 k_t p_1 s^2 + b_1 b_3 m_2 p_1 s^4 + b_1 b_3 m_3 p_1 s^4)}{m_1 m_2 m_3 p_1} \right) \quad (1.9)$$

1.7 iMacroMicro_numpar.txt

MTT command:

```
mtt iMacroMicro numpar txt

m_1 = 0.0169; # m_1;
m_2 = 0.0169; # m_2;
b_1 = 0.13; # b_1;
b_2 = 0.013; # b_2;
k_2 = 24; # k_2;
k_t = 150; # k_t;
b_t = 0.16; # b_t;
b_3 = 0.13; # b_3;
m_3 = 0.005; # m_3;
p_1 = 10; # p_1;
d_1 = 0.9; # d_1;
```

1.8 iMacroMicro_lmfr.ps

MTT command:

```
mtt iMacroMicro lmfr ps
```

This representation is given as Figure 1.3 (on page 16).

1.9 iMacroMicro_lpfr.ps

MTT command:

```
mtt iMacroMicro lpfr ps
```

This representation is given as Figure 1.4 (on page 16).

1.10 iMacroMicro_sro.ps

MTT command:

```
mtt iMacroMicro sro ps
```

This representation is given as Figure 1.5 (on page 17).

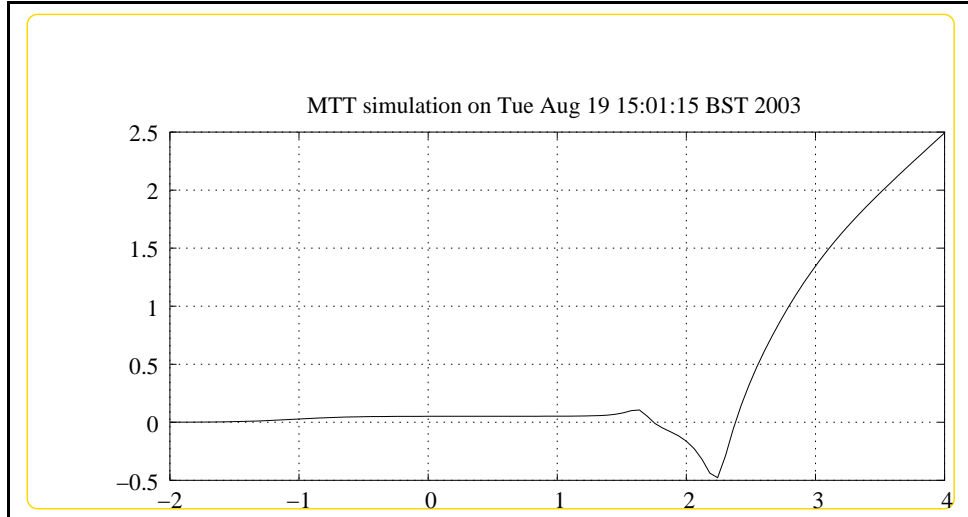

Figure 1.3: System **iMacroMicro**, representation **lmfr (-noargs)**

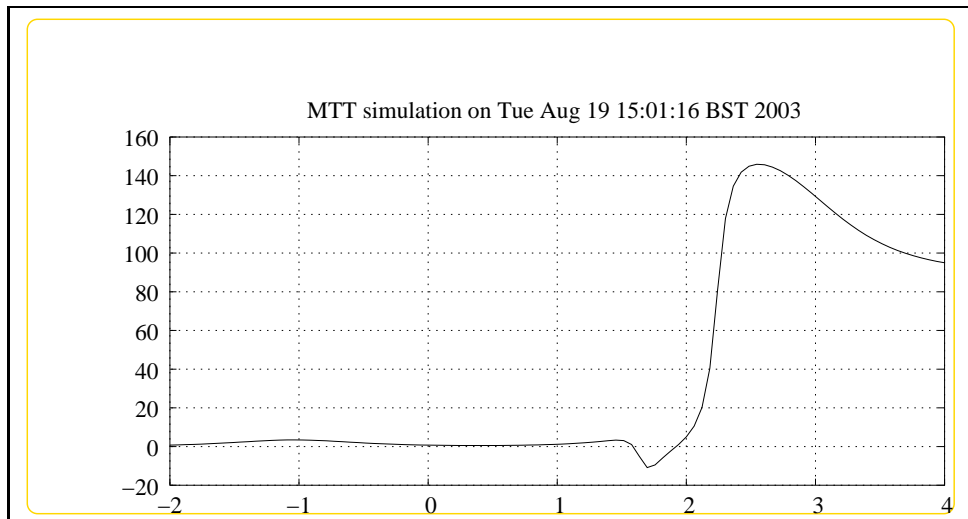

Figure 1.4: System **iMacroMicro**, representation **lpfr (-noargs)**

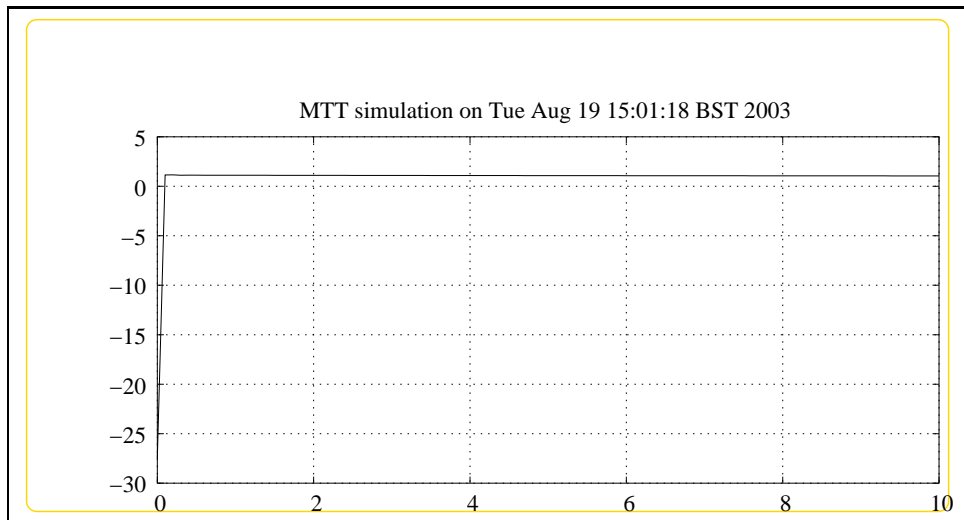

Figure 1.5: System **iMacroMicro**, representation `sro (-noargs)`

1.11 **iMacroMicro_odeso.ps**

MTT command:

```
mtt iMacroMicro odeso ps
```

This representation is given as Figure 1.6 (on page 18).

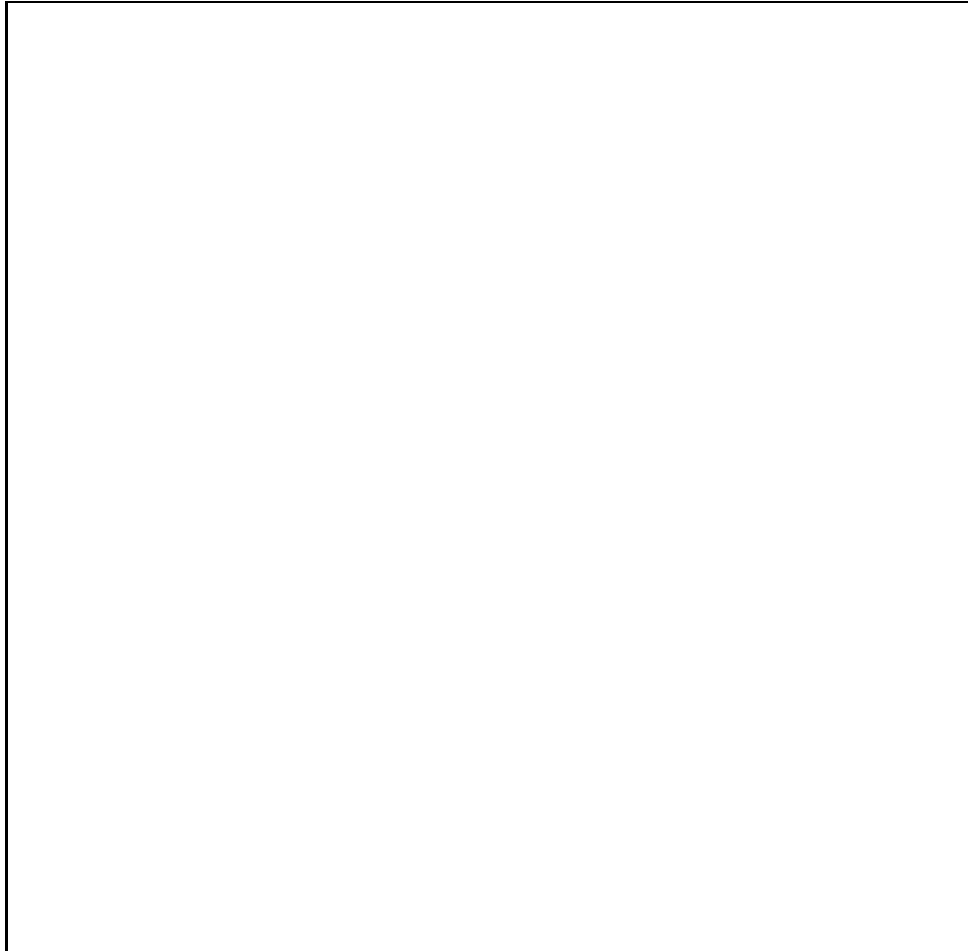

Figure 1.6: System **iMacroMicro**, representation odeso (-noargs)

Part II

iNMP

Chapter 2

NMP

2.1 NMP_abg.tex

MTT command:

```
mtt NMP abg tex
```

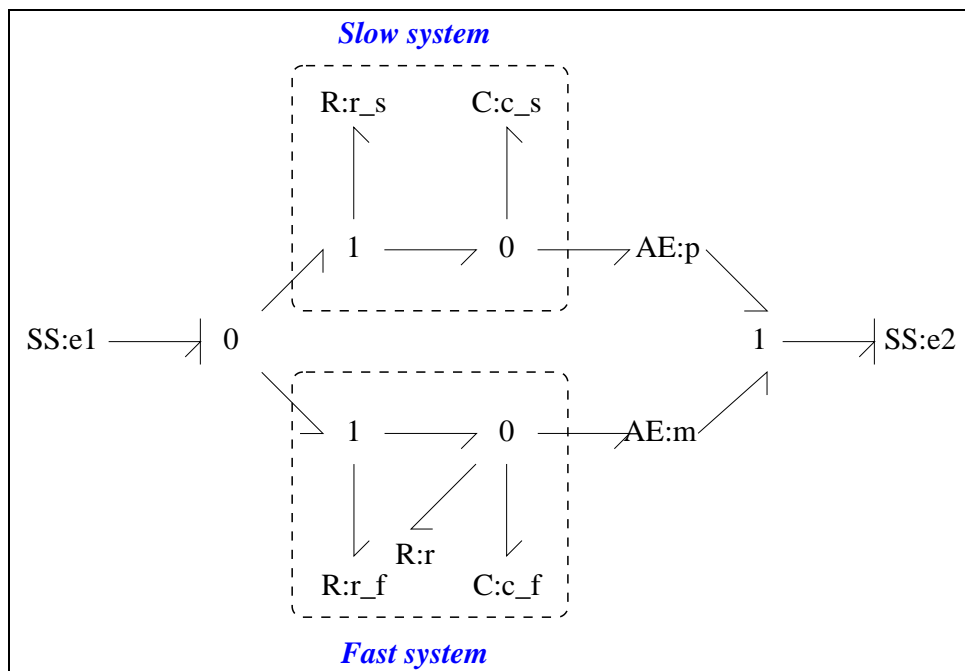

Figure 2.1: System **NMP**: acausal bond graph

The acausal bond graph of system **NMP** is displayed in Figure 2.1 (on page 21) and its label file is listed in Section 2.1.1 (on page 22). The subsystems are listed in Section 2.1.2 (on page 24).

This is a simple non-minimum phase system with an inverse-type response. It is the standard fast negative and slow positive systems in parallel. The corresponding inverse system **iNMP** is unstable.

2.1.1 Summary information

System NMP:A simple non-minimum phase system ;Detailed description here;

Interface information:

Parameter \$1 represents actual parameter **c_f**

Parameter \$2 represents actual parameter **c_s**

Parameter \$3 represents actual parameter **r_f**

Parameter \$4 represents actual parameter **r_s**

Variable declarations:

This component has no PAR declarations

Units declarations:

This component has no UNITS declarations

The label file: **NMP_lbl.txt**

```
%% Label file for system NMP (NMP_lbl.txt)
%SUMMARY NMP A simple non-minimum phase system
%DESCRIPTION <Detailed description here>
```

```
% %%%%%%%%%%%
% %% Version control history
% %%%%%%%%%%%
% %% $Id: NMP_lbl.txt,v 1.3 2003/06/11 16:00:37 gawthrop Exp $
% %% $Log: NMP_lbl.txt,v $
% %% Revision 1.3 2003/06/11 16:00:37 gawthrop
```



```

% %% Updated examples for latest MTT.
% %%
% %% Revision 1.2  2000/05/20 16:40:54  peterg
% %% New SS format
% %%
% %% Revision 1.1  1999/03/09 00:08:21  peterg
% %% Initial revision
% %%
% %%%%%%%%%%%%%%%%%%%%%%%%%%%%%%%%%%%%%%%%%%%%%%%%%%%%%%%%%%%%%%%%%%%%%%%%%%

% Port aliases

% Argument aliases
%ALIAS $1 c_f
%ALIAS $2 c_s
%ALIAS $3 r_f
%ALIAS $4 r_s

%% Each line should be of one of the following forms:
%      a comment (ie starting with %)
%      component-name cr_name arg1,arg2,..argn
%      blank

% ---- Component labels ----

% Component type AE
m lin -1
p lin 1

% Component type C
c_f lin effort,c_f
c_s lin effort,c_s

% Component type R
r lin flow,r
r_f lin flow,r_f
r_s lin flow,r_s

% Component type SS
e1 SS external,internal

```

e2 SS external,0

2.1.2 Subsystems

No subsystems.

2.2 NMP_structex

MTT command:

mtt NMP_structex

List of inputs for system NMP			
	Component	System	Repetition
1	e1	NMP__e1	1

List of outputs for system NMP			
	Component	System	Repetition
1	e2	NMP__e2	1

List of states for system NMP			
	Component	System	Repetition
1	c_f	NMP__c_f	1
2	c_s	NMP__c_s	1

2.3 NMP_ode.tex

MTT command:

mtt NMP_ode.tex

$$\dot{x}_1 = \frac{(c_f u_1 r - x_1 r - x_1 r_f)}{(c_f r r_f)} \quad (2.1)$$

$$\dot{x}_2 = \frac{(c_s u_1 - x_2)}{(c_s r_s)}$$

$$y_1 = \frac{(c_f x_2 - c_s x_1)}{(c_f c_s)} \quad (2.2)$$

2.4 NMP_sm.tex

MTT command:

```
mtt NMP sm tex
```

$$A = \begin{pmatrix} \frac{-(r+r_f)}{c_f r r_f} & 0 \\ 0 & \frac{(-1)}{c_s r_s} \end{pmatrix} \quad (2.3)$$

$$B = \begin{pmatrix} \frac{1}{r_f} \\ \frac{1}{r_s} \end{pmatrix} \quad (2.4)$$

$$C = \begin{pmatrix} \frac{(-1)}{c_f} & \frac{1}{c_s} \end{pmatrix} \quad (2.5)$$

$$D = (0) \quad (2.6)$$

2.5 NMP_tf.tex

MTT command:

```
mtt NMP tf tex
```

$$G = \left(\frac{(c_f r r_f s - c_s r r_s s + r_f)}{(c_f c_s r r_f r_s s^2 + c_f r r_f s + c_s r r_s s + c_s r_f r_s s + r + r_f)} \right) \quad (2.7)$$

2.6 NMP_sro.ps

MTT command:

```
mtt NMP sro ps
```

This representation is given as Figure 2.2 (on page 26).

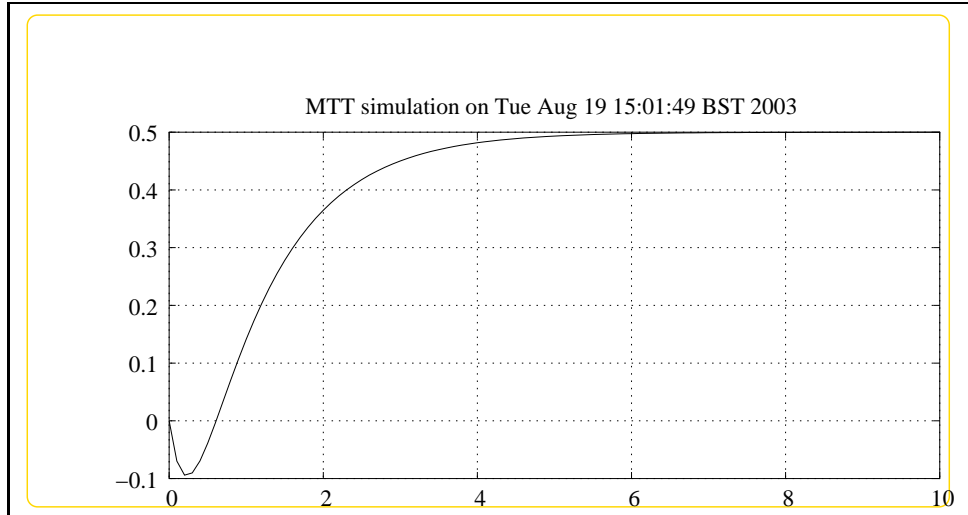

Figure 2.2: System **NMP**, representation sro (-noargs)

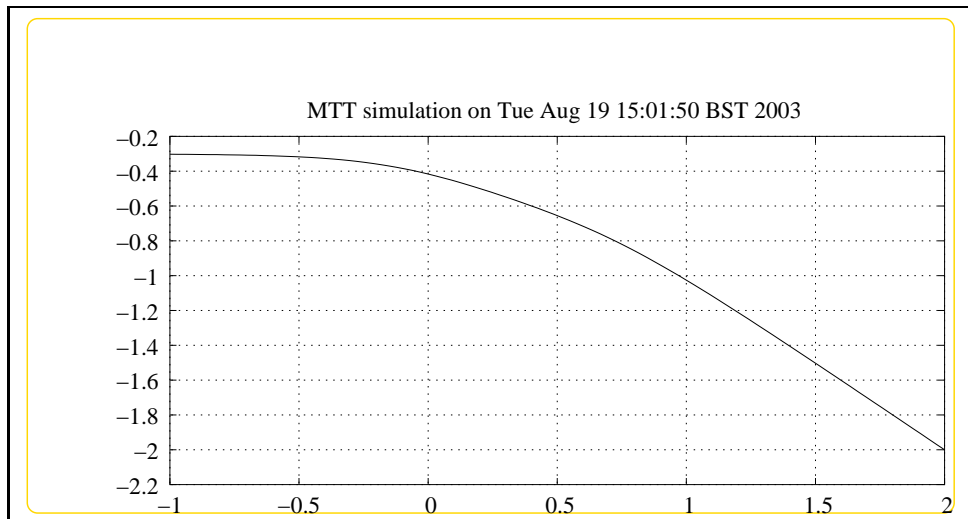

Figure 2.3: System **NMP**, representation lmfr (-noargs)

2.7 NMP_lmfr.ps

MTT command:

```
mtt NMP lmfr ps
```

This representation is given as Figure 2.3 (on page 26).

2.8 NMP_lpfr.ps

MTT command:

```
mtt NMP lpfr ps
```

This representation is given as Figure 2.4 (on page 27).

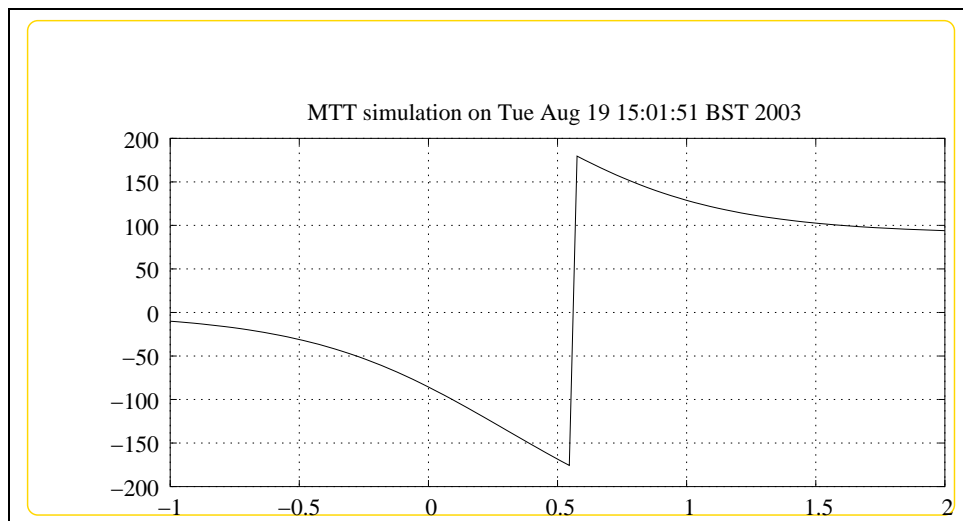

Figure 2.4: System **NMP**, representation **lpfr** (-noargs)

Chapter 3

iNMP

3.1 iNMP_abg.tex

MTT command:

```
mtt iNMP abg tex
```

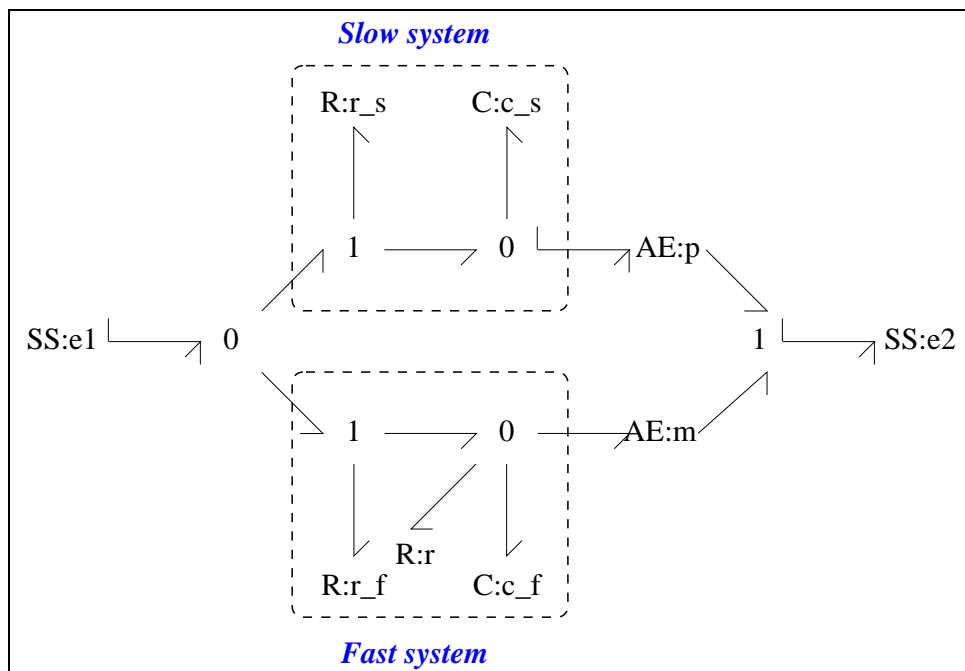

Figure 3.1: System iNMP: acausal bond graph

The acausal bond graph of system **iNMP** is displayed in Figure 3.1 (on page 29) and its label file is listed in Section 3.1.1 (on page 30). The subsystems are listed in Section 3.1.2 (on page 32).

This is a simple non-minimum phase system with an inverse-type response. It is the standard fast negative and slow positive systems in parallel. The corresponding inverse system **iiNMP** is unstable.

3.1.1 Summary information

System iNMP:Inverse simple non-minimum phase system ;Detailed description here;

Interface information:

Parameter \$1 represents actual parameter **c_f**

Parameter \$2 represents actual parameter **c_s**

Parameter \$3 represents actual parameter **r_f**

Parameter \$4 represents actual parameter **r_s**

Variable declarations:

This component has no PAR declarations

Units declarations:

This component has no UNITs declarations

The label file: **iNMP_lbl.txt**

```
%% Label file for system iNMP (iNMP_lbl.txt)
%SUMMARY iNMP Inverse simple non-minimum phase system
%DESCRIPTION <Detailed description here>
```

```
% %%%%%%%%%%
% %% Version control history
% %%%%%%%%%%
% %% $Id: iNMP_lbl.txt,v 1.3 2003/06/11 16:01:00 gawthrop Exp $
% %% $Log: iNMP_lbl.txt,v $
% %% Revision 1.3 2003/06/11 16:01:00 gawthrop
```

```

% %% Updated examples for latest MTT.
% %%
% %% Revision 1.2  2000/05/20 16:42:42  peterg
% %% New SS format
% %%
% %% Revision 1.1  1999/03/09 00:10:07  peterg
% %% Initial revision
% %%
% %%%%%%%%%%%%%%%%%%%%%%%%%%%%%%%%%%%%%%%%%%%%%%%%%%%%%%%%%%

% Port aliases

% Argument aliases
%ALIAS $1 c_f
%ALIAS $2 c_s
%ALIAS $3 r_f
%ALIAS $4 r_s

%% Each line should be of one of the following forms:
%      a comment (ie starting with %)
%      component-name cr_name arg1,arg2,..argn
%      blank

% ---- Component labels ----

% Component type AE
m lin -1
p lin 1

% Component type C
c_f lin effort,c_f
c_s lin effort,c_s

% Component type R
r lin flow,r
r_f lin flow,r_f
r_s lin flow,r_s

% Component type SS
e1 SS external,internal

```

e2 SS external,0

3.1.2 Subsystems

No subsystems.

3.2 iNMP_struct.tex

MTT command:

mtt iNMP_struct.tex

List of inputs for system iNMP			
	Component	System	Repetition
1	e2	iNMP__e2	1

List of nonstates for system iNMP			
	Component	System	Repetition
1	c_s	iNMP__c_s	1

List of outputs for system iNMP			
	Component	System	Repetition
1	e1	iNMP__e1	1

List of states for system iNMP			
	Component	System	Repetition
1	c_f	iNMP__c_f	1

3.3 iNMP_ode.tex

MTT command:

mtt iNMP_ode.tex

$$\dot{x}_1 = \frac{(c_f r_f (c_f c_s \dot{u}_1 r r_s + c_f u_1 r - x_1 r_f))}{\left(r (c_f^2 r_f^2 - 2c_f c_s r_f r_s + c_s^2 r_s^2)\right)} \quad (3.1)$$

$$y_1 = \frac{\left(c_f^3 c_s \dot{u}_1 r r_f^2 r_s + c_f^3 u_1 r r_f^2 - c_f^2 c_s^2 \dot{u}_1 r r_f r_s^2 - c_f^2 c_s u_1 r r_f r_s + c_f^2 x_1 r r_f^2 + c_f c_s^3 \dot{u}_1 r r_s^3 + c_f c_s^2 u_1 r r_s^2 - 2c_f c_s x_1 r r_f r_s\right)}{\left(c_f r (c_f^2 r_f^2 - 2c_f c_s r_f r_s + c_s^2 r_s^2)\right)} \quad (3.2)$$

3.4 iNMP_dm.tex

MTT command:

```
mtt iNMP dm tex
```

$$E = \begin{pmatrix} 1 & 0 & 0 \\ 0 & 1 & 0 \\ 0 & 0 & 0 \end{pmatrix} \quad (3.3)$$

$$A = \begin{pmatrix} \frac{(-1)}{(c_f r)} & 0 & \frac{r_s}{r_f} \\ 0 & 0 & 1 \\ \frac{c_s}{c_f} & -1 & 0 \end{pmatrix} \quad (3.4)$$

$$B = \begin{pmatrix} \frac{1}{r_f} \\ 0 \\ c_s \end{pmatrix} \quad (3.5)$$

$$C = \left(\frac{1}{c_f} \quad 0 \quad r_s\right) \quad (3.6)$$

$$D = (1) \quad (3.7)$$

3.5 iNMP_tf.tex

MTT command:

```
mtt iNMP tf tex
```

$$G = \left(\frac{(c_f c_s r r_f r_s s^2 + c_f r r_f s + c_s r r_s s + c_s r_f r_s s + r + r_f)}{(c_f r r_f s - c_s r r_s s + r_f)} \right) \quad (3.8)$$

3.6 iNMP_lmfr.ps

MTT command:

```
mtt iNMP lmfr ps
```

This representation is given as Figure 3.2 (on page 34).

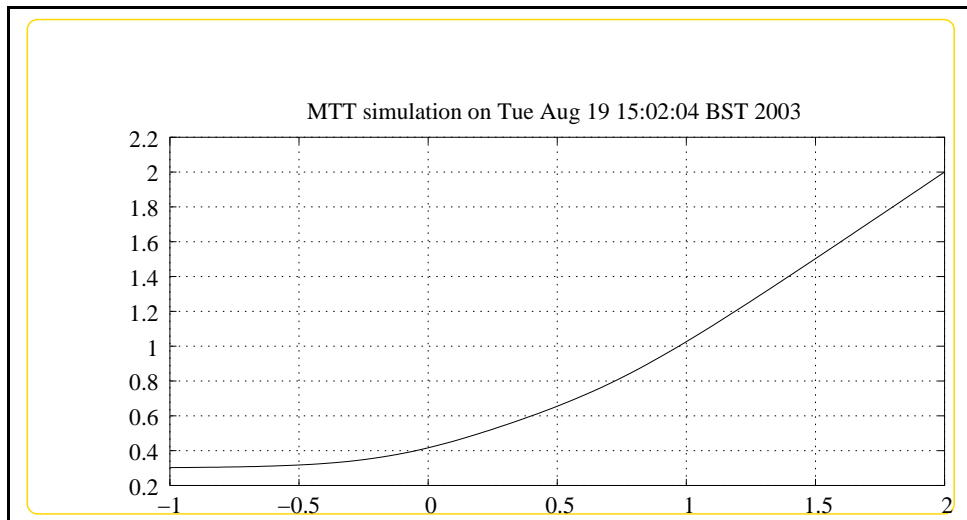

Figure 3.2: System **iNMP**, representation **lmfr** (-noargs)

3.7 iNMP_lpfr.ps

MTT command:

```
mtt iNMP lpfr ps
```

This representation is given as Figure 3.3 (on page 35).

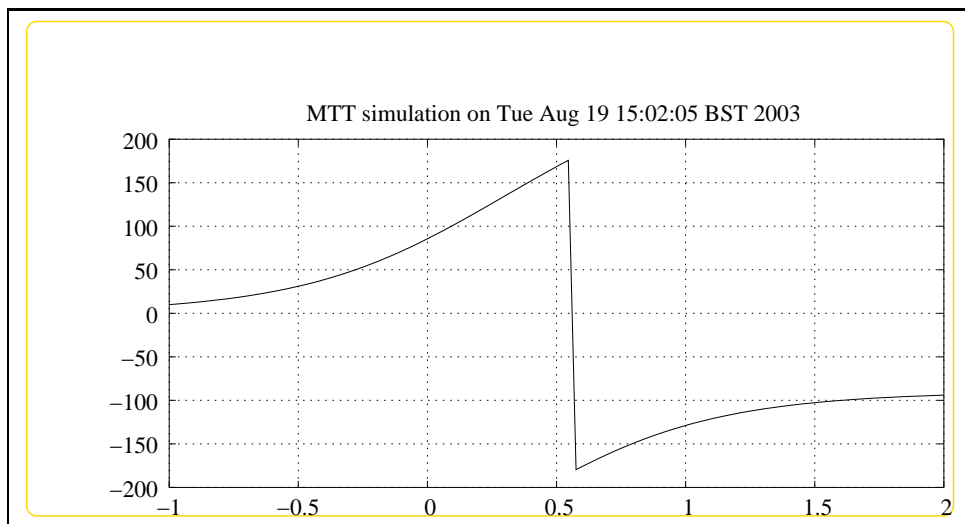

Figure 3.3: System **iNMP**, representation lpfr (-noargs)

Part III

iRC2

Chapter 4

iRC2c

4.1 iRC2c_abg.tex

MTT command:

```
mtt iRC2c abg tex
```

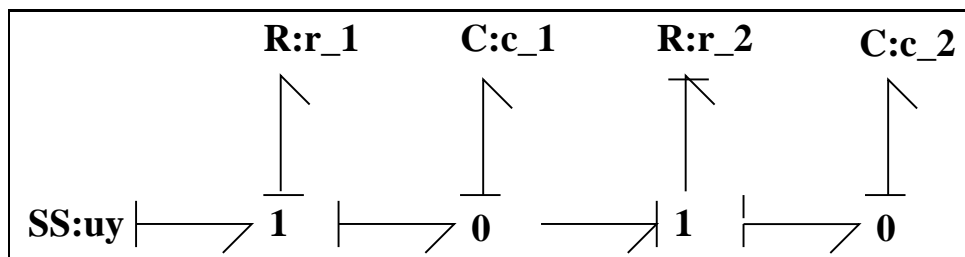

Figure 4.1: System **iRC2c**: acausal bond graph

The acausal bond graph of system **iRC2c** is displayed in Figure 4.1 (on page 39) and its label file is listed in Section 4.1.1 (on page 39). The subsystems are listed in Section 4.1.2 (on page 41).

This example gives the inverse of a double RC circuit with *collocated* sensor/actuator pairing.

4.1.1 Summary information

System iRC2c: Inverse of double RC circuit with collocated io ; Detailed description here;

Interface information:

This component has no ALIAS declarations

Variable declarations:

This component has no PAR declarations

Units declarations:

This component has no UNITS declarations

The label file: iRC2c_lbl.txt

```
%SUMMARY iRC2c Inverse of double RC circuit with collocated io
%DESCRIPTION <Detailed description here>
%% Label file for system iRC2c (iRC2c_lbl.txt)
```

```
% %%%%%%%%%%%%%%%%%%%%%%%%%%%%%%%%%%%%%%%%%%%%%%%%%%%%%%%%%%%%%%%%%%%%%%%%%
% %% Version control history
% %%%%%%%%%%%%%%%%%%%%%%%%%%%%%%%%%%%%%%%%%%%%%%%%%%%%%%%%%%%%%%%%%%%%%%%%%
% %% $Id: iRC2c_lbl.txt,v 1.1 2000/12/28 17:52:17 peterg Exp $
% %% $Log: iRC2c_lbl.txt,v $
% %% Revision 1.1 2000/12/28 17:52:17 peterg
% %% To RCS
% %%
% %%%%%%%%%%%%%%%%%%%%%%%%%%%%%%%%%%%%%%%%%%%%%%%%%%%%%%%%%%%%%%%%%%%%%%%%%
```

```
%% Each line should be of one of the following forms:
% a comment (ie starting with %)
% Component-name CR_name arg1,arg2,..argn
% blank
```

```
% Component type C
c_1 lin effort,c_1
c_2 lin effort,c_2
```

```
% Component type R
r_1 lin flow,r_1
r_2 lin flow,r_2
```

```
% Component type SS
uy SS external,external
```

4.1.2 Subsystems

No subsystems.

4.2 iRC2c_struct.tex

MTT command:

```
mtt iRC2c struc tex
```

List of inputs for system iRC2c			
	Component	System	Repetition
1	uy	iRC2c__uy	1

List of outputs for system iRC2c			
	Component	System	Repetition
1	uy	iRC2c__uy_2	1

List of states for system iRC2c			
	Component	System	Repetition
1	c_1	iRC2c__c_1	1
2	c_2	iRC2c__c_2	1

4.3 iRC2c_dae.tex

MTT command:

```
mtt iRC2c dae tex
```

$$\begin{aligned} \dot{x}_1 &= \frac{(c_1 c_2 u_1 r_2 + c_1 x_2 - c_2 x_1)}{(c_1 c_2 r_2)} \\ \dot{x}_2 &= \frac{(-c_1 x_2 + c_2 x_1)}{(c_1 c_2 r_2)} \end{aligned} \quad (4.1)$$

$$y_1 = \frac{(c_1 u_1 r_1 + x_1)}{c_1} \quad (4.2)$$

4.4 iRC2c_dm.tex

MTT command:

```
mtt iRC2c dm tex
```

$$A = \begin{pmatrix} \frac{(-1)}{(c_1 r_2)} & \frac{1}{(c_2 r_2)} \\ \frac{1}{(c_1 r_2)} & \frac{(-1)}{(c_2 r_2)} \end{pmatrix} \quad (4.3)$$

$$B = \begin{pmatrix} 1 \\ 0 \end{pmatrix} \quad (4.4)$$

$$C = \left(\frac{1}{c_1} \quad 0 \right) \quad (4.5)$$

$$D = (r_1) \quad (4.6)$$

4.5 iRC2c_tf.tex

MTT command:

```
mtt iRC2c tf tex
```

$$G = \left(\frac{(c_1 c_2 r_1 r_2 s^2 + c_1 r_1 s + c_2 r_1 s + c_2 r_2 s + 1)}{(s(c_1 c_2 r_2 s + c_1 + c_2))} \right) \quad (4.7)$$

Chapter 5

iRC2n

5.1 iRC2n_abg.tex

MTT command:

```
mtt iRC2n abg tex
```

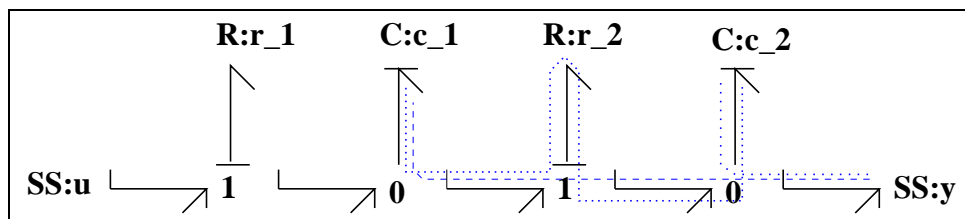

Figure 5.1: System **iRC2n**: acausal bond graph

The acausal bond graph of system **iRC2n** is displayed in Figure 5.1 (on page 43) and its label file is listed in Section 5.1.1 (on page 43). The subsystems are listed in Section 5.1.2 (on page 45).

This example gives the inverse of a double RC circuit with *non-located* sensor/actuator pairing.

5.1.1 Summary information

System iRC2n: Inverse of double RC circuit with non-located io

⌋Detailed description here⌋

Interface information:

This component has no ALIAS declarations

Variable declarations:

This component has no PAR declarations

Units declarations:

This component has no UNITS declarations

The label file: iRC2n_lbl.txt

```
%SUMMARY iRC2n Inverse of double RC circuit with non-collocated ic
%DESCRIPTION <Detailed description here>
%% Label file for system iRC2n (iRC2n_lbl.txt)
```

```
% %%%%%%%%%%
% %% Version control history
% %%%%%%%%%%
% %% $Id: iRC2n_lbl.txt,v 1.1 2000/12/28 17:53:01 peterg Exp $
% %% $Log: iRC2n_lbl.txt,v $
% %% Revision 1.1 2000/12/28 17:53:01 peterg
% %% To RCS
% %%
% %% Revision 1.1 2000/05/20 16:43:52 peterg
% %% Initial revision
% %%
% %%%%%%%%%%
```

```
%% Each line should be of one of the following forms:
% a comment (ie starting with %)
% Component-name CR_name arg1,arg2,..argn
% blank
```

```
% Component type C
c_1 lin effort,c_1
c_2 lin effort,c_2
```

```
% Component type R
r_1 lin flow,r_1
r_2 lin flow,r_2
```

```
% Component type SS
u SS external,internal
y SS external,0
```

5.1.2 Subsystems

No subsystems.

5.2 iRC2n_struct.tex

MTT command:

```
mtt iRC2n struc tex
```

List of inputs for system iRC2n			
	Component	System	Repetition
1	y	iRC2n_y	1

List of nonstates for system iRC2n			
	Component	System	Repetition
1	c_1	iRC2n_c_1	1
2	c_2	iRC2n_c_2	1

List of outputs for system iRC2n			
	Component	System	Repetition
1	u	iRC2n_u	1

5.3 iRC2n_dae.tex

MTT command:

```
mtt iRC2n dae tex
```

$$\begin{aligned} z_1 &= c_1(\dot{z}_2 r_2 + y) \\ z_2 &= c_2 y \end{aligned} \tag{5.1}$$

$$y_1 = \dot{z}_1 r_1 + \dot{z}_2 r_1 + \dot{z}_2 r_2 + y \tag{5.2}$$

5.4 iRC2n_dm.tex

MTT command:

```
mtt iRC2n dm tex
```

$$E = \begin{pmatrix} 1 & 0 & 0 & 0 \\ 0 & 1 & 0 & 0 \\ 0 & 0 & 0 & 0 \\ 0 & 0 & 0 & 0 \end{pmatrix} \quad (5.3)$$

$$A = \begin{pmatrix} 0 & 0 & 1 & 0 \\ 0 & 0 & 0 & 1 \\ -1 & 0 & 0 & c_1 r_2 \\ 0 & -1 & 0 & 0 \end{pmatrix} \quad (5.4)$$

$$B = \begin{pmatrix} 0 \\ 0 \\ c_1 \\ c_2 \end{pmatrix} \quad (5.5)$$

$$C = (0 \quad 0 \quad r_1 \quad r_1 + r_2) \quad (5.6)$$

$$D = (1) \quad (5.7)$$

5.5 iRC2n_tf.tex

MTT command:

```
mtt iRC2n tf tex
```

$$G = (c_1 c_2 r_1 r_2 s^2 + c_1 r_1 s + c_2 r_1 s + c_2 r_2 s + 1) \quad (5.8)$$

Chapter 6

saRC2c

6.1 saRC2c_abg.tex

MTT command:

```
mtt saRC2c abg tex
```

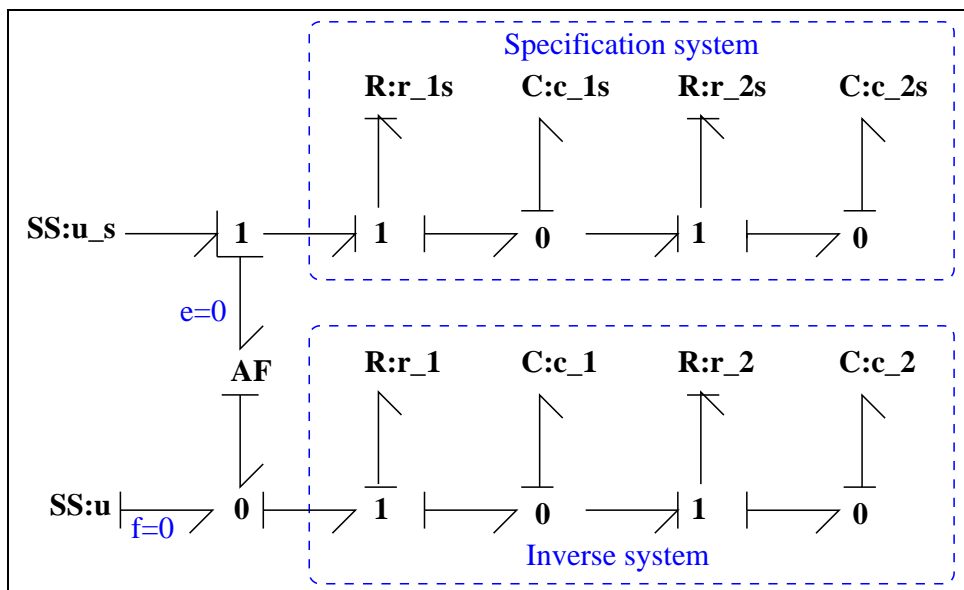

Figure 6.1: System **saRC2c**: acausal bond graph

The acausal bond graph of system **saRC2c** is displayed in Figure 6.1 (on page 47) and its label file is listed in Section 6.1.1 (on page 48). The subsystems are listed in Section 6.1.2 (on page 49).

This example gives the inverse of a double RC circuit with

- specification system,
- amplifier connection and
- collocated sensor/actuator pairing.

6.1.1 Summary information

System saRC2c: ;Detailed description here;

Interface information:

This component has no ALIAS declarations

Variable declarations:

This component has no PAR declarations

Units declarations:

This component has no UNITS declarations

The label file: saRC2c_lbl.txt

```
%SUMMARY saRC2c
%DESCRIPTION <Detailed description here>
%% Label file for system saRC2c (saRC2c_lbl.txt)

% %%%%%%%%%%%%%%%%%%%%%%%%%%%%%%%%%%%%%%%%%%%%%%%%%%%%%%%%%%%
% %% Version control history
% %%%%%%%%%%%%%%%%%%%%%%%%%%%%%%%%%%%%%%%%%%%%%%%%%%%%%%%%%%%
% %% $Id: saRC2c_lbl.txt,v 1.1 2000/12/28 17:53:33 peterg Exp $
% %% $Log: saRC2c_lbl.txt,v $
% %% Revision 1.1 2000/12/28 17:53:33 peterg
% %% To RCS
% %%
% %%%%%%%%%%%%%%%%%%%%%%%%%%%%%%%%%%%%%%%%%%%%%%%%%%%%%%%%%%%

%% Each line should be of one of the following forms:
%% a comment (ie starting with %)
```

```

% Component-name CR_name arg1,arg2,..argn
% blank

% Component type C
c_1 lin effort,c_1
c_1s lin effort,c_1s
c_2 lin effort,c_2
c_2s lin effort,c_2s

% Component type R
r_1 lin flow,r_1
r_1s lin flow,r_1s
r_2 lin flow,r_2
r_2s lin flow,r_2s

% Component type SS
u SS external,0
u_s SS external,external

```

6.1.2 Subsystems

No subsystems.

6.2 saRC2c_struct.tex

MTT command:

```
mtt saRC2c struc tex
```

List of inputs for system saRC2c			
	Component	System	Repetition
1	u_s	saRC2c__u_s	1

List of outputs for system saRC2c			
	Component	System	Repetition
1	u	saRC2c__u	1
2	u_s	saRC2c__u_s	1

List of states for system saRC2c			
	Component	System	Repetition
1	c_1	saRC2c__c_1	1
2	c_1s	saRC2c__c_1s	1
3	c_2	saRC2c__c_2	1
4	c_2s	saRC2c__c_2s	1

6.3 saRC2c_dae.tex

MTT command:

```
mtt saRC2c dae tex
```

$$\begin{aligned}
 \dot{x}_1 &= \frac{(c_1 c_{1s} c_2 u_1 r_2 + c_1 c_{1s} x_3 r_{1s} - c_1 c_2 x_2 r_2 - c_{1s} c_2 x_1 r_{1s})}{(c_1 c_{1s} c_2 r_{1s} r_2)} \\
 \dot{x}_2 &= \frac{(c_{1s} c_2 u_1 r_{2s} + c_{1s} x_4 r_{1s} - c_2 x_2 r_{1s} - c_2 x_2 r_{2s})}{(c_{1s} c_2 r_{1s} r_{2s})} \\
 \dot{x}_3 &= \frac{(-c_1 x_3 + c_2 x_1)}{(c_1 c_2 r_2)} \\
 \dot{x}_4 &= \frac{(-c_{1s} x_4 + c_2 x_2)}{(c_{1s} c_2 r_{2s})}
 \end{aligned} \tag{6.1}$$

$$\begin{aligned}
 y_1 &= \frac{(c_1 c_{1s} u_1 r_1 - c_1 x_2 r_1 + c_{1s} x_1 r_{1s})}{(c_1 c_{1s} r_{1s})} \\
 y_2 &= \frac{(c_{1s} u_1 - x_2)}{(c_{1s} r_{1s})}
 \end{aligned} \tag{6.2}$$

6.4 saRC2c_dm.tex

MTT command:

```
mtt saRC2c dm tex
```

$$A = \begin{pmatrix} \frac{(-1)}{(c_1 r_2)} & \frac{(-1)}{(c_{1s} r_{1s})} & \frac{1}{(c_2 r_2)} & 0 \\ 0 & \frac{(-r_{1s} + r_{2s})}{(c_{1s} r_{1s} r_{2s})} & 0 & \frac{1}{(c_2 r_{2s})} \\ \frac{1}{(c_1 r_2)} & 0 & \frac{(-1)}{(c_2 r_2)} & 0 \\ 0 & \frac{1}{(c_{1s} r_{2s})} & 0 & \frac{(-1)}{(c_2 r_{2s})} \end{pmatrix} \tag{6.3}$$

$$B = \begin{pmatrix} \frac{1}{r_1 s} \\ \frac{1}{r_1 s} \\ 0 \\ 0 \end{pmatrix} \quad (6.4)$$

$$C = \begin{pmatrix} \frac{1}{c_1} & \frac{(-r_1)}{(c_1 s r_1 s)} & 0 & 0 \\ 0 & \frac{(-1)}{(c_1 s r_1 s)} & 0 & 0 \end{pmatrix} \quad (6.5)$$

$$D = \begin{pmatrix} r_1 \\ \frac{1}{r_1 s} \\ \frac{1}{r_1 s} \end{pmatrix} \quad (6.6)$$

6.5 saRC2c_tf.tex

MTT command:

```
mtt saRC2c tf tex
```

$$G = \begin{pmatrix} \frac{(c_1 c_1 s c_2 c_2 s r_1 r_2 r_2 s^3 + c_1 c_1 s c_2 r_1 r_2 s^2 + c_1 c_1 s c_2 s r_1 r_2 s^2 + c_1 c_1 s r_1 s + c_1 c_2 c_2 s r_1 r_2 s^2 + c_1 c_2 s r_1 s + c_1 s c_2 c_2 s r_1 r_2 s^2 + c_1 s c_2 c_2 s r_2 r_2 s^2 + c_1 s c_2 r_2 s^2 + c_1 c_1 s c_2 c_2 s r_1 r_2 r_2 s^3 + c_1 c_1 s c_2 r_1 s r_2 s^2 + c_1 c_1 s c_2 s r_1 s r_2 s^2 + c_1 c_1 s r_1 s s + c_1 c_2 c_2 s r_1 s r_2 s^2 + c_1 c_2 c_2 s r_2 r_2 s^2 + c_1 c_2 r_2 s + c_1 c_2 s r_1 s s + c_1 c_2 s r_2 s s + c_1 c_2 s r_2 s s + c_1 s c_2 c_2 s r_1 r_2 s^2 + c_1 s c_2 r_2 s s + c_1 s + c_2 s)}{(c_1 s c_2 s r_1 s r_2 s^2 + c_1 s r_1 s + c_2 s r_1 s s + c_2 s r_2 s s + 1)} \end{pmatrix} \quad (6.7)$$

6.6 saRC2c_odeso.ps

MTT command:

```
mtt saRC2c odeso ps
```

This representation is given as Figure 6.2 (on page 52).

6.7 saRC2c_lmfr.ps

MTT command:

```
mtt saRC2c lmfr ps
```

This representation is given as Figure 6.3 (on page 52).

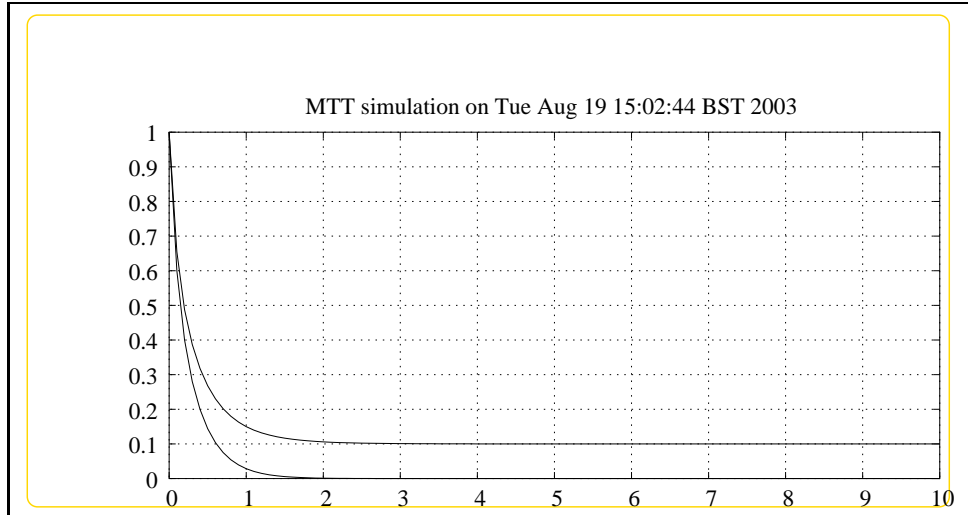

Figure 6.2: System **saRC2c**, representation odeso (-noargs)

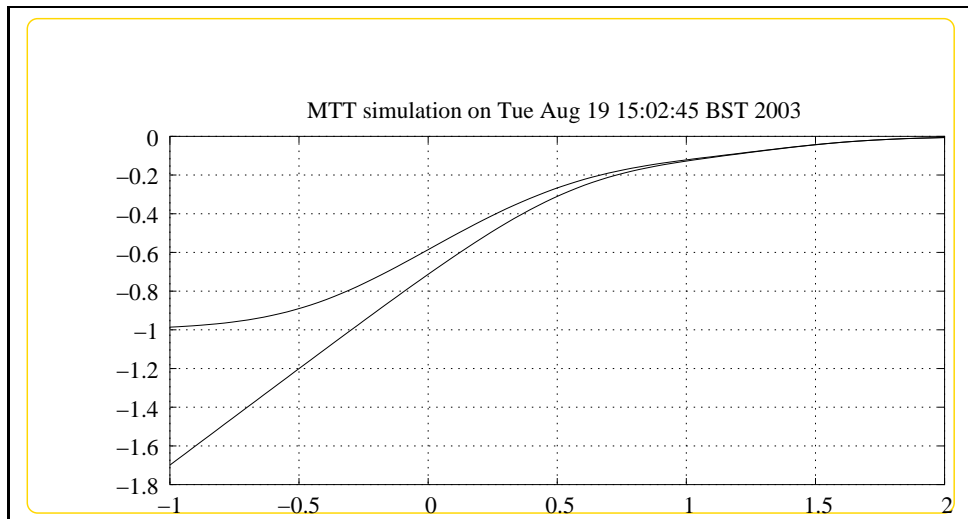

Figure 6.3: System **saRC2c**, representation lmfr (-noargs)

Chapter 7

szRC2c

7.1 szRC2c_abg.tex

MTT command:

```
mtt szRC2c abg tex
```

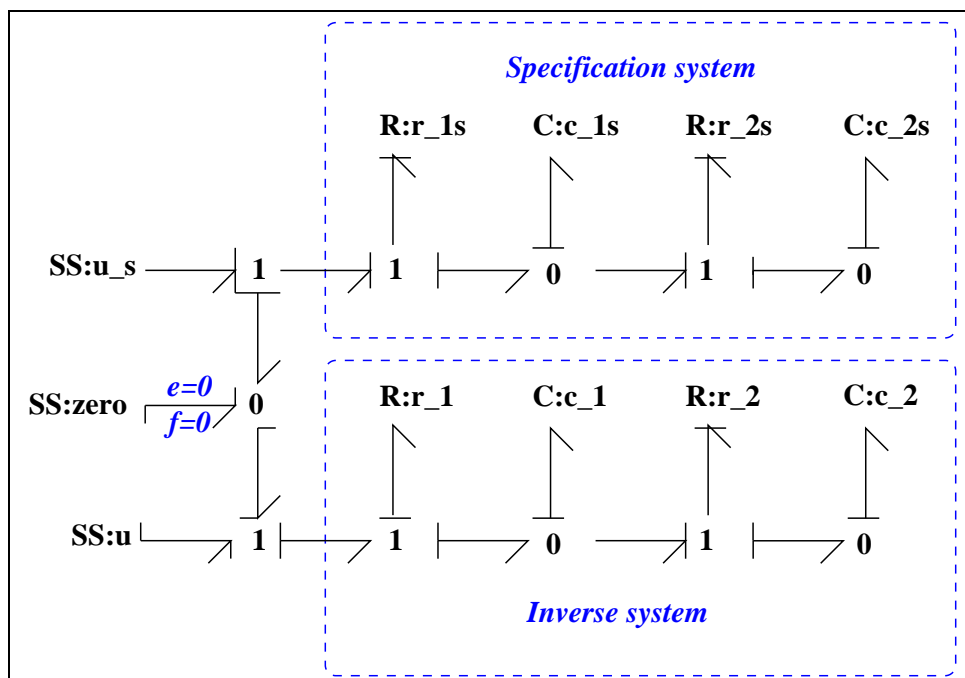

Figure 7.1: System **szRC2c**: acausal bond graph

The acausal bond graph of system **szRC2c** is displayed in Figure 7.1 (on page 53) and its label file is listed in Section 7.1.1 (on page 54). The subsystems are listed in Section 7.1.2 (on page 55).

This example gives the inverse of a double RC circuit with

- specification system,
- zero-zero **SS** connection and
- collocated sensor/actuator pairing.

7.1.1 Summary information

System szRC2c:Specification inverse of double RC circuit with collocated io
 ;Detailed description here;

Interface information:

This component has no ALIAS declarations

Variable declarations:

This component has no PAR declarations

Units declarations:

This component has no UNITS declarations

The label file: szRC2c_lbl.txt

```
%SUMMARY szRC2c Specification inverse of double RC circuit with co
%DESCRIPTION <Detailed description here>
%% Label file for system szRC2c (szRC2c_lbl.txt)

% %%%%%%%%%%%%%%%%%%%%%%%%%%%%%%%%%%%%%%%%%%%%%%%%%%%%%%%%%%%
% %% Version control history
% %%%%%%%%%%%%%%%%%%%%%%%%%%%%%%%%%%%%%%%%%%%%%%%%%%%%%%%%%%%
% %% $Id: szRC2c_lbl.txt,v 1.2 2003/06/11 16:01:44 gawthrop Exp $
% %% $Log: szRC2c_lbl.txt,v $
% %% Revision 1.2 2003/06/11 16:01:44 gawthrop
% %% Updated examples for latest MTT.
% %%
```

```

% %% Revision 1.1  2000/12/28 17:54:15  peterg
% %% To RCS
% %%
% %% Revision 1.1  2000/05/20 16:44:55  peterg
% %% Initial revision
% %%
% %%%%%%%%%%%%%%%%%%%%%%%%%%%%%%%%%%%%%%%%%%%%%%%%%%%%%%%%%%%%%%%%%%%%%%%%%%

%% Each line should be of one of the following forms:
% a comment (ie starting with %)
% Component-name CR_name arg1,arg2,..argn
% blank

% Component type C
c_1 lin effort,c_1
c_1s lin effort,c_1s
c_2 lin effort,c_2
c_2s lin effort,c_2s

% Component type R
r_1 lin flow,r_1
r_1s lin flow,r_1s
r_2 lin flow,r_2
r_2s lin flow,r_2s

% Component type SS
u_s SS external,external
zero SS 0,0
u SS external,internal

```

7.1.2 Subsystems

No subsystems.

7.2 szRC2c_struct.tex

MTT command:

```
mtt szRC2c struc tex
```

List of inputs for system szRC2c			
	Component	System	Repetition
1	u_s	szRC2c_u_s	1

List of outputs for system szRC2c			
	Component	System	Repetition
1	u_s	szRC2c_u_s_2	1
2	u	szRC2c_u	1

List of states for system szRC2c			
	Component	System	Repetition
1	c_1	szRC2c_c_1	1
2	c_1s	szRC2c_c_1s	1
3	c_2	szRC2c_c_2	1
4	c_2s	szRC2c_c_2s	1

7.3 szRC2c_dae.tex

MTT command:

```
mtt szRC2c dae tex
```

$$\begin{aligned}
 \dot{x}_1 &= \frac{(c_1 c_{1s} c_2 u_1 r_2 + c_1 c_{1s} x_3 r_{1s} - c_1 c_2 x_2 r_2 - c_{1s} c_2 x_1 r_{1s})}{(c_1 c_{1s} c_2 r_{1s} r_2)} \\
 \dot{x}_2 &= \frac{(c_{1s} c_2 u_1 r_{2s} + c_{1s} x_4 r_{1s} - c_2 x_2 r_{1s} - c_2 x_2 r_{2s})}{(c_{1s} c_2 r_{1s} r_{2s})} \\
 \dot{x}_3 &= \frac{(-c_1 x_3 + c_2 x_1)}{(c_1 c_2 r_2)} \\
 \dot{x}_4 &= \frac{(-c_{1s} x_4 + c_2 x_2)}{(c_{1s} c_2 r_{2s})}
 \end{aligned} \tag{7.1}$$

$$\begin{aligned}
 y_1 &= \frac{(c_{1s} u_1 - x_2)}{(c_{1s} r_{1s})} \\
 y_2 &= \frac{(c_1 c_{1s} u_1 r_1 - c_1 x_2 r_1 + c_{1s} x_1 r_{1s})}{(c_1 c_{1s} r_{1s})}
 \end{aligned} \tag{7.2}$$

7.6 **zRC2c_odeso.ps**

MTT command:

```
mtt zRC2c odeso ps
```

This representation is given as Figure 7.2 (on page 58).



Figure 7.2: System **zRC2c**, representation odeso (-noargs)

7.7 **szRC2c_lmfr.ps**

MTT command:

```
mtt szRC2c lmfr ps
```

This representation is given as Figure 7.3 (on page 59).

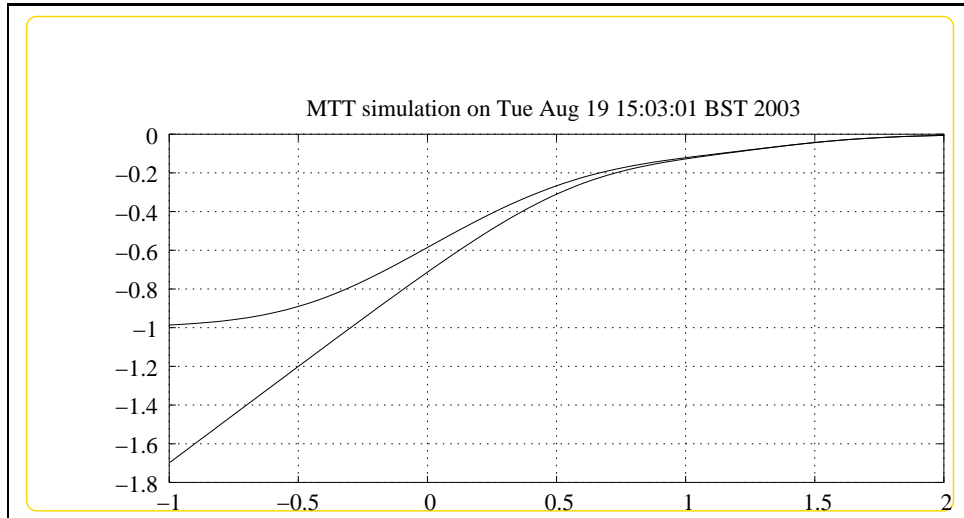

Figure 7.3: System **szRC2c**, representation **lmfr (-noargs)**

Chapter 8

szRC2n

8.1 szRC2n_abg.tex

MTT command:

```
mtt szRC2n abg tex
```

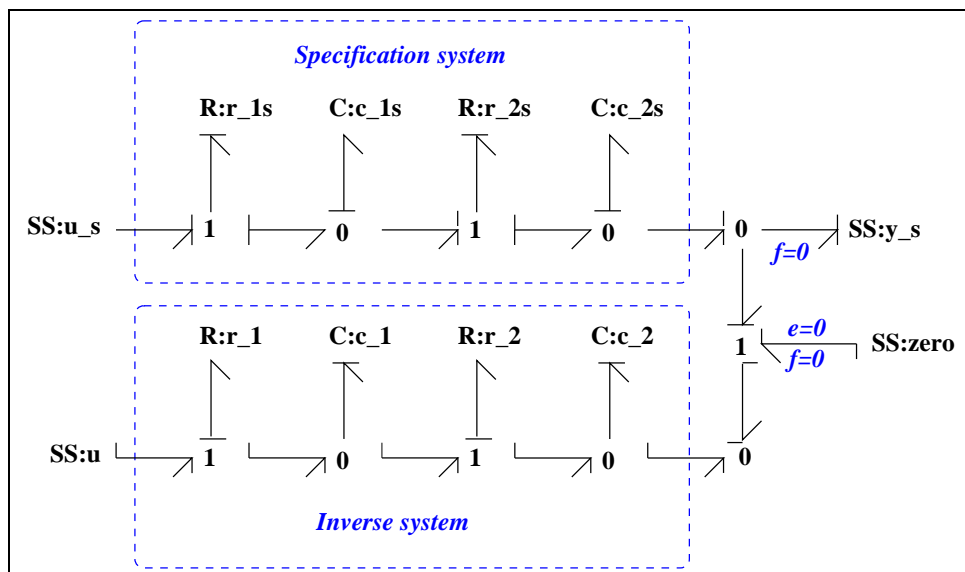

Figure 8.1: System **szRC2n**: acausal bond graph

The acausal bond graph of system **szRC2n** is displayed in Figure 8.1 (on page 61) and its label file is listed in Section 8.1.1 (on page 62). The subsystems are listed in Section 8.1.2 (on page 63).

This example gives the inverse of a double RC circuit with

- specification system,
- zero-zero **SS** connection and
- non-collocated sensor/actuator pairing.

8.1.1 Summary information

System szRC2n:Specification inverse of double RC circuit with noncollocated io ⌋Detailed description here⌋

Interface information:

This component has no ALIAS declarations

Variable declarations:

This component has no PAR declarations

Units declarations:

This component has no UNITS declarations

The label file: szRC2n_lbl.txt

```
%SUMMARY szRC2n Specification inverse of double RC circuit with no
%DESCRIPTION <Detailed description here>
%% Label file for system szRC2n (szRC2n_lbl.txt)
```

```
% %%%%%%%%%%%%%%%%%%%%%%%%%%%%%%%%%%%%%%%%%%%%%%%%%%%%%%%%%%%%%%%%%%%%%%%%%
% %% Version control history
% %%%%%%%%%%%%%%%%%%%%%%%%%%%%%%%%%%%%%%%%%%%%%%%%%%%%%%%%%%%%%%%%%%%%%%%%%
% %% $Id: szRC2n_lbl.txt,v 1.2 2003/06/11 16:02:21 gawthrop Exp $
% %% $Log: szRC2n_lbl.txt,v $
% %% Revision 1.2 2003/06/11 16:02:21 gawthrop
% %% Updated examples for latest MTT.
% %%
% %% Revision 1.1 2000/12/28 17:54:46 peterg
% %% To RCS
% %%
% %% Revision 1.1 2000/05/20 16:45:37 peterg
% %% Initial revision
```



```

% %%
% %%%%%%%%%%%%%%%%%%%%%%%%%%%%%%%%%%%%%%%%%%%%%%%%%%%%%%%%%%
%% Each line should be of one of the following forms:
% a comment (ie starting with %)
% Component-name CR_name arg1,arg2,..argn
% blank

% Component type C
c_1 lin effort,c_1
c_1s lin effort,c_1s
c_2 lin effort,c_2
c_2s lin effort,c_2s

% Component type R
r_1 lin flow,r_1
r_1s lin flow,r_1s
r_2 lin flow,r_2
r_2s lin flow,r_2s

% Component type SS
u_s SS external,internal
y_s SS external,0
zero SS 0,0
u SS external,internal

```

8.1.2 Subsystems

No subsystems.

8.2 szRC2n_struct.tex

MTT command:

```
mtt szRC2n_struct.tex
```

List of inputs for system szRC2n			
	Component	System	Repetition
1	u_s	szRC2n_u_s	1

List of nonstates for system szRC2n			
	Component	System	Repetition
1	c_1	szRC2n_c_1	1
2	c_2	szRC2n_c_2	1

List of outputs for system szRC2n			
	Component	System	Repetition
1	y_s	szRC2n_y_s	1
2	u	szRC2n_u	1

List of states for system szRC2n			
	Component	System	Repetition
1	c_1s	szRC2n_c_1s	1
2	c_2s	szRC2n_c_2s	1

8.3 szRC2n_dae.tex

MTT command:

mtt szRC2n dae tex

$$\dot{x}_1 = \frac{(c_{1s}c_{2s}u_1r_{2s} + c_{1s}x_2r_{1s} - c_{2s}x_1r_{1s} - c_{2s}x_1r_{2s})}{(c_{1s}c_{2s}r_{1s}r_{2s})} \quad (8.1)$$

$$\dot{x}_2 = \frac{(-c_{1s}x_2 + c_{2s}x_1)}{(c_{1s}c_{2s}r_{2s})}$$

$$z_1 = \frac{(c_1(c_{2s}\dot{z}_2r_2 + x_2))}{c_{2s}} \quad (8.2)$$

$$z_2 = \frac{(c_2x_2)}{c_{2s}}$$

$$y_1 = \frac{x_2}{c_{2s}} \quad (8.3)$$

$$y_2 = \frac{(c_{2s}\dot{z}_1r_1 + c_{2s}\dot{z}_2r_1 + c_{2s}\dot{z}_2r_2 + x_2)}{c_{2s}}$$

8.4 szRC2n_dm.tex

MTT command:

```
mtt szRC2n dm tex
```

$$E = \begin{pmatrix} 1 & 0 & 0 & 0 & 0 & 0 \\ 0 & 1 & 0 & 0 & 0 & 0 \\ 0 & 0 & 1 & 0 & 0 & 0 \\ 0 & 0 & 0 & 1 & 0 & 0 \\ 0 & 0 & 0 & 0 & 0 & 0 \\ 0 & 0 & 0 & 0 & 0 & 0 \end{pmatrix} \quad (8.4)$$

$$A = \begin{pmatrix} \frac{-(r_{1s}+r_{2s})}{(c_{1s}r_{1s}r_{2s})} & \frac{1}{(c_{2s}r_{2s})} & 0 & 0 & 0 & 0 \\ \frac{1}{(c_{1s}r_{2s})} & \frac{(-1)}{(c_{2s}r_{2s})} & 0 & 0 & 0 & 0 \\ 0 & 0 & 0 & 0 & 1 & 0 \\ 0 & 0 & 0 & 0 & 0 & 1 \\ 0 & \frac{c_1}{c_{2s}} & -1 & 0 & 0 & c_1r_2 \\ 0 & \frac{c_2}{c_{2s}} & 0 & -1 & 0 & 0 \end{pmatrix} \quad (8.5)$$

$$B = \begin{pmatrix} \frac{1}{r_{1s}} \\ 0 \\ 0 \\ 0 \\ 0 \\ 0 \end{pmatrix} \quad (8.6)$$

$$C = \begin{pmatrix} 0 & \frac{1}{c_{2s}} & 0 & 0 & 0 & 0 \\ 0 & \frac{1}{c_{2s}} & 0 & 0 & r_1 & r_1 + r_2 \end{pmatrix} \quad (8.7)$$

$$D = \begin{pmatrix} 0 \\ 0 \end{pmatrix} \quad (8.8)$$

8.5 szRC2n_tf.tex

MTT command:

```
mtt szRC2n tf tex
```

$$G = \begin{pmatrix} \frac{1}{(c_{1s}c_{2s}r_{1s}r_{2s}s^2 + c_{1s}r_{1s}s + c_{2s}r_{1s}s + c_{2s}r_{2s}s + 1)} \\ \frac{(c_1c_2r_1r_2s^2 + c_1r_1s + c_2r_1s + c_2r_2s + 1)}{(c_{1s}c_{2s}r_{1s}r_{2s}s^2 + c_{1s}r_{1s}s + c_{2s}r_{1s}s + c_{2s}r_{2s}s + 1)} \end{pmatrix} \quad (8.9)$$

8.6 szRC2n_odeso.ps

MTT command:

```
mtt szRC2n odeso ps
```

This representation is given as Figure 8.2 (on page 66).

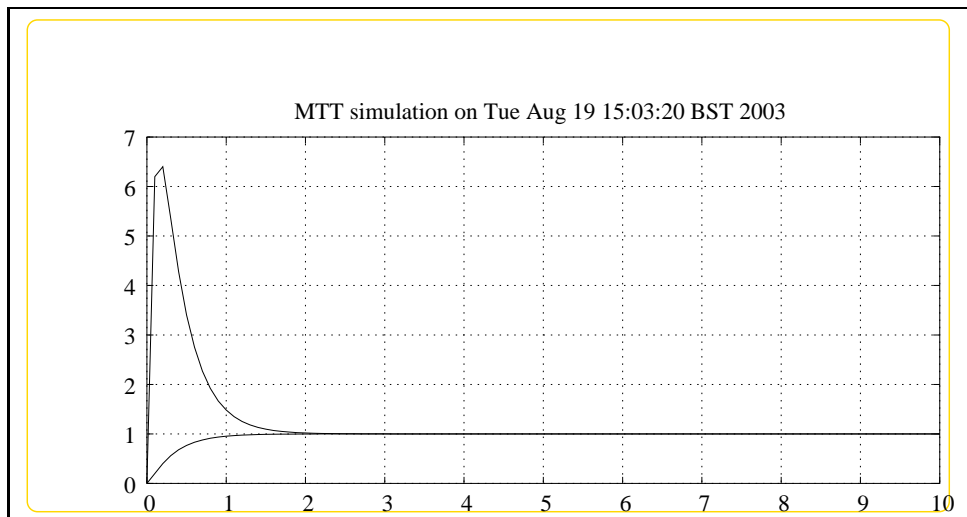

Figure 8.2: System **szRC2n**, representation odeso (-noargs)

8.7 szRC2n_lmfr.ps

MTT command:

```
mtt szRC2n lmfr ps
```

This representation is given as Figure 8.3 (on page 67).

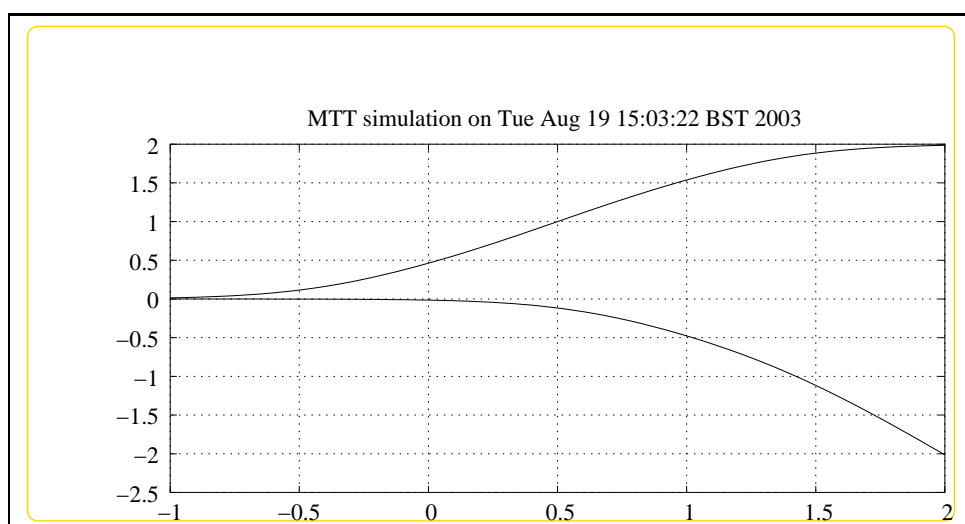

Figure 8.3: System **szRC2n**, representation **lmfr (-noargs)**

Part IV

Inverse

Chapter 9

iTanks

9.1 iTanks_abg.tex

MTT command:

```
mtt iTanks abg tex
```

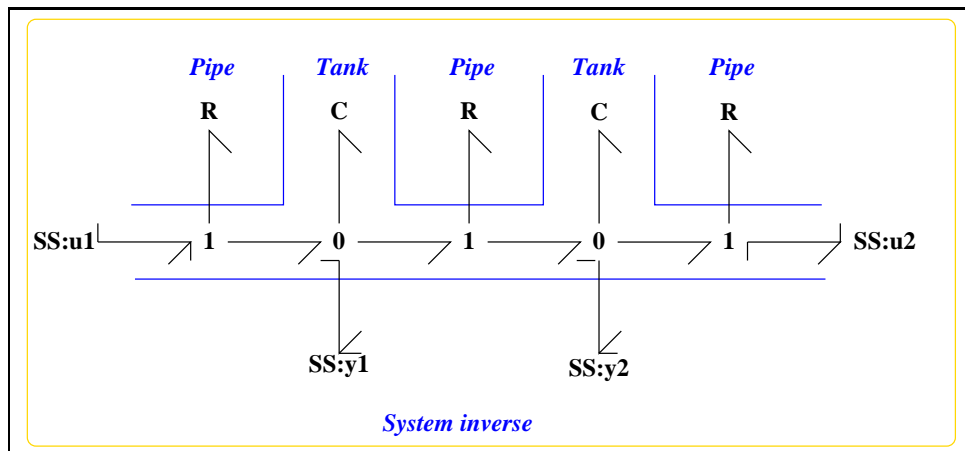

Figure 9.1: System **iTanks**: acausal bond graph

Figure 9.1 (on page 71) shows the bond graph of a two-tank system superimposed on a schematic diagram. The two **C** components corresponds to the fluid storage and how it relates to the pressure at the base of the tanks. In this case, for simplicity, each tank ($i = 1$ or $i = 2$) is assumed to have a unity constitutive relationship:

$$\text{pressure} = p_i = v_i = \text{volume} \quad (9.1)$$

The volumetric flow rate into the first, and out of the second, tank is represented by the two unlabelled **R** components. Again, each is assumed to have a unit constitutive relationship:

$$\text{flow} = f_i = \Delta_i = \text{pressure drop} \quad (9.2)$$

The volumetric flow rate between the first and the second tanks is represented **R** component labelled k . The constitutive relationship is assumed linear of the form:

$$\text{flow} = f = k\Delta = \text{pressure drop} \quad (9.3)$$

The system has two inputs:

$$u_1 = \text{input pressure at left-hand pipe} \quad (9.4)$$

$$u_2 = \text{input pressure at right-hand pipe}$$

and two outputs:

$$y_1 = p_1 = \text{pressure at left-hand tank} \quad (9.5)$$

$$y_2 = p_2 = \text{pressure at right-hand tank}$$

The system transfer-function matrix is given by:

$$G_{11} = G_{22} = \frac{(s + k + 1)}{(s^2 + 2s(k + 1) + 2k + 1)} \quad (9.6)$$

$$G_{12} = G_{21} = \frac{k}{(s^2 + 2s(k + 1) + 2k + 1)}$$

However, Figure 9.1 (on page 71) shows the causality of the **SS** components to *invert* the system with respect to its inputs and outputs. Figure ?? (on page ??) shows the causally complete bond graph; this system has no dynamic components in integral causality – the inverse has no poles and therefore the system has no zeros.

Some further representations of the inverse appear in the following sections.

9.1.1 Summary information

System iTanks::Inversion of a two-tanks system This inverse system has no poles thus the system itself has no (multivariable) zeros

Interface information:

This component has no ALIAS declarations

Variable declarations:

This component has no PAR declarations

Units declarations:

This component has no UNITS declarations

The label file: iTanks_lbl.txt

```
%SUMMARY iTanks: Inversion of a two-tanks system
%DESCRIPTION This inverse system has no poles thus
%DESCRIPTION the system itself has no (multivariable) zeros
%% Label file for system iTanks (iTanks_lbl.txt)
```

```
% %%%%%%%%%%%%%%%%%%%%%%%%%%%%%%%%%%%%%%%%%%%%%%%%%%%%%%%%%%%%%%%%%%%%%%%%%
% %% Version control history
% %%%%%%%%%%%%%%%%%%%%%%%%%%%%%%%%%%%%%%%%%%%%%%%%%%%%%%%%%%%%%%%%%%%%%%%%%
% %% $Id: iTanks_lbl.txt,v 1.1 2000/05/20 16:46:10 peterg Exp $
% %% $Log: iTanks_lbl.txt,v $
% %% Revision 1.1 2000/05/20 16:46:10 peterg
% %% Initial revision
% %%
% %%%%%%%%%%%%%%%%%%%%%%%%%%%%%%%%%%%%%%%%%%%%%%%%%%%%%%%%%%%%%%%%%%%%%%%%%
```

%% Each line should be of one of the following forms:

```
% a comment (ie starting with %)
% Component-name CR_name arg1,arg2,..argn
% blank
```

```
% Component type SS
u1 SS external,internal
u2 SS external,internal
y1 SS external,0
y2 SS external,0
```

9.1.2 Subsystems

No subsystems.

9.2 iTanks_cbg.ps

MTT command:

```
mtt iTanks cbg ps
```

This representation is given as Figure 9.2 (on page 74).

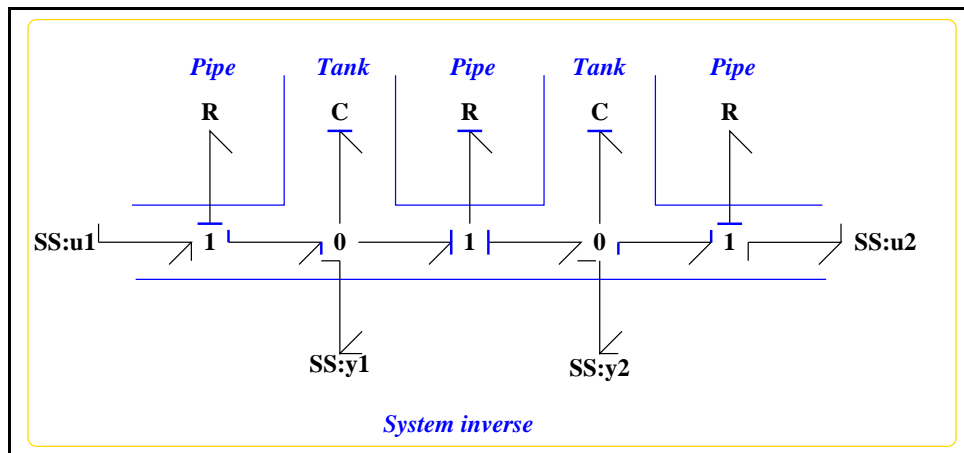

Figure 9.2: System **iTanks**, representation cbg (-noargs)

9.3 iTanks_struct.tex

MTT command:

```
mtt iTanks struc tex
```

List of inputs for system iTanks			
	Component	System	Repetition
1	y1	iTanks_y1	1
2	y2	iTanks_y2	1

List of nonstates for system iTanks			
	Component	System	Repetition
1	mttC	iTanks_mttC	1
2	mttC_2	iTanks_mttC_2	1

List of outputs for system iTanks			
	Component	System	Repetition
1	u1	iTanks_u1	1
2	u2	iTanks_u2	1

9.4 iTanks_dm.tex

MTT command:

```
mtt iTanks dm tex
```

$$E = \begin{pmatrix} 1 & 0 & 0 & 0 \\ 0 & 1 & 0 & 0 \\ 0 & 0 & 0 & 0 \\ 0 & 0 & 0 & 0 \end{pmatrix} \quad (9.7)$$

$$A = \begin{pmatrix} 0 & 0 & 1 & 0 \\ 0 & 0 & 0 & 1 \\ -1 & 0 & 0 & 0 \\ 0 & -1 & 0 & 0 \end{pmatrix} \quad (9.8)$$

$$B = \begin{pmatrix} 0 & 0 \\ 0 & 0 \\ 0 & 1 \\ 1 & 0 \end{pmatrix} \quad (9.9)$$

$$C = \begin{pmatrix} 0 & 0 & 0 & 1 \\ 0 & 0 & 1 & 0 \end{pmatrix} \quad (9.10)$$

$$D = \begin{pmatrix} 2 & -1 \\ -1 & 2 \end{pmatrix} \quad (9.11)$$

9.5 iTanks_tf.tex

MTT command:

```
mtt iTanks tf tex
```

$$G = \begin{pmatrix} s+2 & -1 \\ -1 & s+2 \end{pmatrix} \quad (9.12)$$

9.6 iTanks_lmfr.ps

MTT command:

```
mtt iTanks lmfr ps
```

This representation is given as Figure 9.3 (on page 77).

9.7 iTanks_lpfr.ps

MTT command:

```
mtt iTanks lpfr ps
```

This representation is given as Figure 9.4 (on page 78).

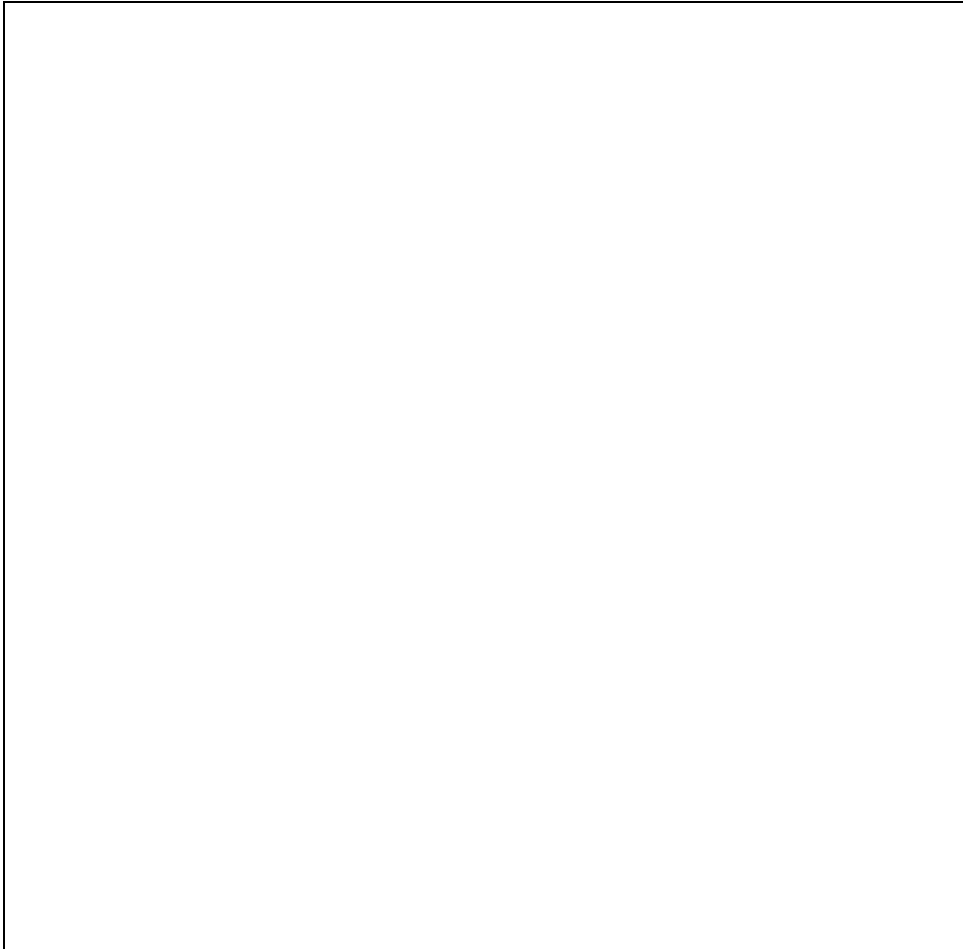

Figure 9.3: System **iTanks**, representation `lmfr (-noargs)`

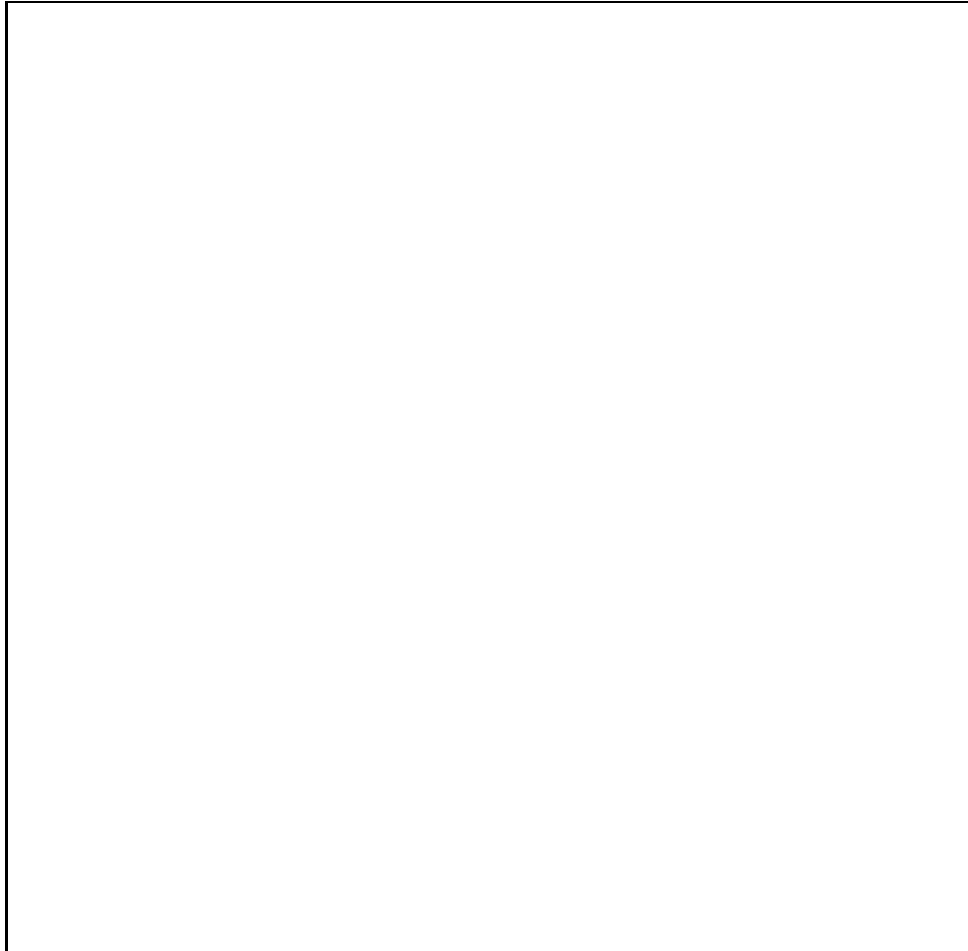

Figure 9.4: System **iTanks**, representation lpfr (-noargs)

Chapter 10

iTwoLink

10.1 iTwoLink_abg.tex

MTT command:

```
mtt iTwoLink abg tex
```

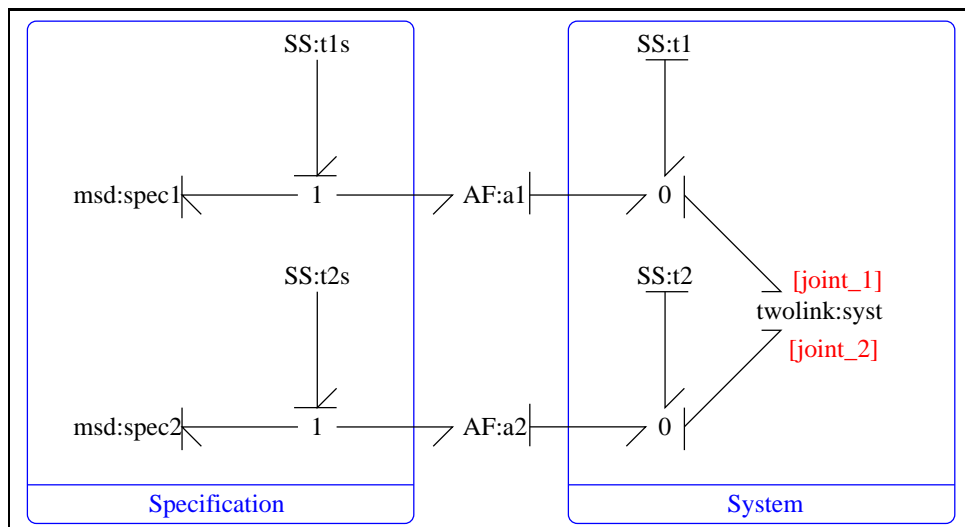

Figure 10.1: System **iTwoLink**: acausal bond graph

The acausal bond graph of system **iTwoLink** is displayed in Figure 10.1 (on page 79) and its label file is listed in Section 10.1.1 (on page 80). The subsystems are listed in Section 10.1.2 (on page 82).

This example illustrates the inversion of two link manipulator dynamics using two identical simple mass-spring-damper systems as specification systems.

The velocities $\omega_1 = \omega_2$ specified by the specification systems are given in Figure ?? (on page ??) together with the input defined in Section ?? (on page ??). The torques τ_1 and τ_2 required to give these velocities specified by the specification system are given in Figures ?? (on page ??) and ?? (on page ??) respectively.

The corresponding velocity/torque diagrams for joints 1 and 2 appear in Figures ?? (on page ??) ?? (on page ??) respectively. Such diagrams can be used for actuator sizing in terms of torque, velocity and power.

This non-linear system can be linearised (about the various configurations) and small-signal frequency response methods applied. For example, the four transfer functions G_{11} to G_{22} in Section ?? (on page ??) (representing the system linearised about zero angles and velocities), give the small-signal relations between the two spec. torques and the required system torques. Used together with G_{31} and G_{42} (relating the spec. torques and the joint velocities) gives, in principle, a method for evaluating actuator requirements (for small signals) as a function of frequency.

10.1.1 Summary information

System iTwoLink::Inverse of two-link manipulator Uses the specification system idea to get an ordinary differential equation inverse.

Interface information:

Component INTF is in library **General/INTF**

Variable declarations:

This component has no PAR declarations

Units declarations:

This component has no UNITS declarations

The label file: iTwoLink_lbl.txt

```
%SUMMARY iTwoLink: Inverse of two-link manipulator
%DESCRIPTION Uses the specification system idea to get an ordinary
%DESCRIPTION differential equation inverse.
%% Label file for system iTwoLink (iTwoLink_lbl.txt)
```

```

% %%%%%%%%%%
% %% Version control history
% %%%%%%%%%%
% %% $Id: iTwoLink_lbl.txt,v 1.2 2000/05/20 16:50:22 peterg Exp $
% %% $Log: iTwoLink_lbl.txt,v $
% %% Revision 1.2 2000/05/20 16:50:22 peterg
% %% New SS format
% %%
% %% Revision 1.1 1998/11/17 15:50:45 peterg
% %% Initial revision
% %%
% %%%%%%%%%%

```

```
%ALIAS INTF General/INTF
```

```
%% Each line should be of one of the following forms:
```

```

% a comment (ie starting with %)
% Component-name CR_name arg1,arg2,..argn
% blank

```

```
% Component type AF
```

```

a1 lin flow,1
a2 lin flow,1

```

```
% Component type SS
```

```

t1 SS external,0
t2 SS external,0
t1s SS external,external
t2s SS external,external

```

```
% Component type msd
```

```

spec1
spec2

```

```
% Component type onelink
```

```

syst

```

10.1.2 Subsystems

- msd: Simple mass-spring damper (2) No subsystems.
- twolink: two-link manipulator from Section 10.5 of "Metamodelling" (1)
 - ROD: rigid rod in two dimensions (2)

10.1.3 INTF

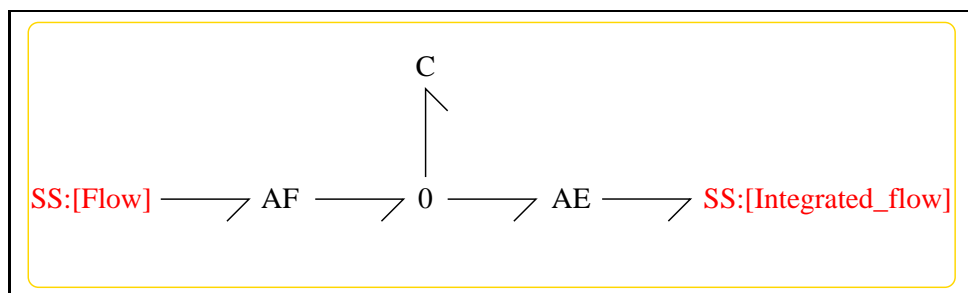

Figure 10.2: System **INTF**: acausal bond graph

The acausal bond graph of system **INTF** is displayed in Figure 10.2 (on page 82) and its label file is listed in Section 10.1.3 (on page 82). The subsystems are listed in Section 10.1.3 (on page 84).

INTF is a two-port component where the effort on port [out] is the integral of the flow on port [in].

Summary information

System INTF::flow integrator Port [in]: Flow to be integrated Port [out]: Effort = integral of flow on port [in]

Interface information:

Port in represents actual port **Flow**

Port out represents actual port **Integrated_flow**

Variable declarations:

This component has no PAR declarations

Units declarations:

This component has no UNITS declarations

The label file: INTF_lbl.txt

```

%% Label file for system INTF (INTF_lbl.txt)
%SUMMARY INTF: flow integrator
%DESCRIPTION Port [in]: Flow to be integrated
%DESCRIPTION Port [out]: Effort = integral of flow on port [in]

% %%%%%%%%%%%%%%%%%%%%%%%%%%%%%%%%%%%%%%%%%%%%%%%%%%%%%%%%%%
% %% Version control history
% %%%%%%%%%%%%%%%%%%%%%%%%%%%%%%%%%%%%%%%%%%%%%%%%%%%%%%%%%%
% %% $Id: INTF_lbl.txt,v 1.3 1998/07/16 07:35:10 peterg Exp $
% %% $Log: INTF_lbl.txt,v $
% %% Revision 1.3 1998/07/16 07:35:10 peterg
% %% Aliased version
% %%
% %%%%%%%%%%%%%%%%%%%%%%%%%%%%%%%%%%%%%%%%%%%%%%%%%%%%%%%%%%

% Port aliases
%ALIAS in Flow
%ALIAS out Integrated_flow

% Argument aliases

%% Each line should be of one of the following forms:
%     a comment (ie starting with %)
%     component-name cr_name arg1,arg2,..argn
%     blank

% ---- Component labels ----

% Component type SS
[Flow] SS external,external
[Integrated_flow] SS external,external

```

Subsystems

No subsystems.

10.1.4 ROD

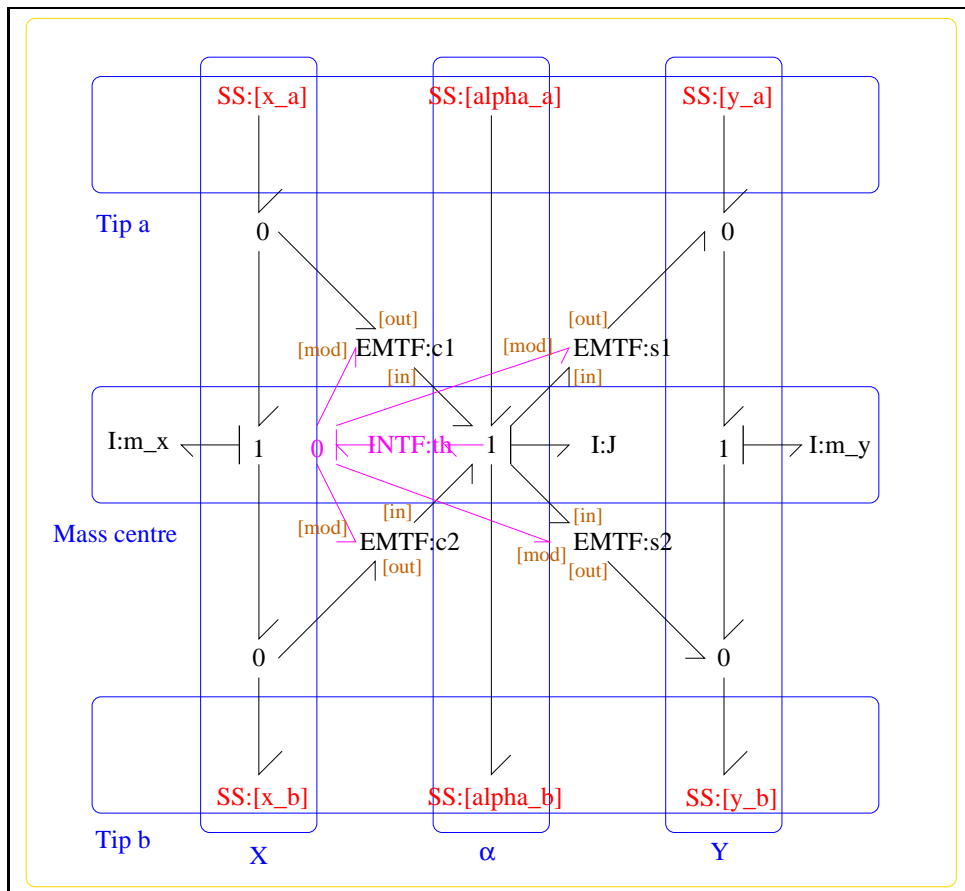

Figure 10.3: System **ROD**: acausal bond graph

The acausal bond graph of system **ROD** is displayed in Figure 10.3 (on page 84) and its label file is listed in Section 10.1.4 (on page 85). The subsystems are listed in Section 10.1.4 (on page 86).

ROD is essentially as described in Figure 10.2 of “Metamodelling”.

Summary information

System ROD::rigid rod in two dimensions Port [alpha_a]: Angular torque/velocity - end a Port [alpha_b]: Angular torque/velocity - end b Port [x_a]: x force/velocity - end a Port [x_b]: x force/velocity - end b Port [y_a]: y force/velocity - end a Port [y_b]: y force/velocity - end b
 Parameter 1: length from end 1 to mass centre Parameter 2: length from end 2 to mass centre Parameter 3: inertia about mass centre Parameter 4: mass See Section 10.2 of "Metamodelling"

Interface information:

This component has no ALIAS declarations

Variable declarations:

This component has no PAR declarations

Units declarations:

This component has no UNITS declarations

The label file: ROD_lbl.txt

```
%SUMMARY ROD: rigid rod in two dimensions
%DESCRIPTION Port [alpha_a]: Angular torque/velocity - end a
%DESCRIPTION Port [alpha_b]: Angular torque/velocity - end b
%DESCRIPTION Port [x_a]: x force/velocity - end a
%DESCRIPTION Port [x_b]: x force/velocity - end b
%DESCRIPTION Port [y_a]: y force/velocity - end a
%DESCRIPTION Port [y_b]: y force/velocity - end b
%DESCRIPTION
%DESCRIPTION Parameter 1: length from end 1 to mass centre
%DESCRIPTION Parameter 2: length from end 2 to mass centre
%DESCRIPTION Parameter 3: inertia about mass centre
%DESCRIPTION Parameter 4: mass
%DESCRIPTION See Section 10.2 of "Metamodelling"

%% Label file for system ROD (ROD_lbl.txt)
```

```

% %%%%%%%%%%%%%%%%%%%%%%%%%%%%%%%%%%%%%%%%%%%%%%%%%%%%%%%%%%
% %% Version control history
% %%%%%%%%%%%%%%%%%%%%%%%%%%%%%%%%%%%%%%%%%%%%%%%%%%%%%%%%%%
% %% $Id: ROD_lbl.txt,v 1.3 2000/12/28 17:56:50 peterg Exp $
% %% $Log: ROD_lbl.txt,v $
% %% Revision 1.3  2000/12/28 17:56:50  peterg
% %% To RCS
% %%
% %% Revision 1.2  1997/08/15  09:43:06  peterg
% %% Now has labelled (as opposed to numbered) ports.
% %%
% Revision 1.1  1996/11/07  10:57:17  peterg
% Initial revision
%
% %%%%%%%%%%%%%%%%%%%%%%%%%%%%%%%%%%%%%%%%%%%%%%%%%%%%%%%%%%

```

%% Each line should be of one of the following forms:

```

% a comment (ie starting with %)
% Component-name CR_name arg1,arg2,..argn
% blank

```

```

%Inertias
J lin flow,$3
m_x lin flow,$4
m_y lin flow,$4

```

```

%Integrate angular velocity to get angle
th

```

```

%Modulated transformers
s1 lsin flow,$1
s2 lsin flow,$2
c1 lcos flow,$1
c2 lcos flow,$2

```

Subsystems

- INTF: flow integrator (1) No subsystems.

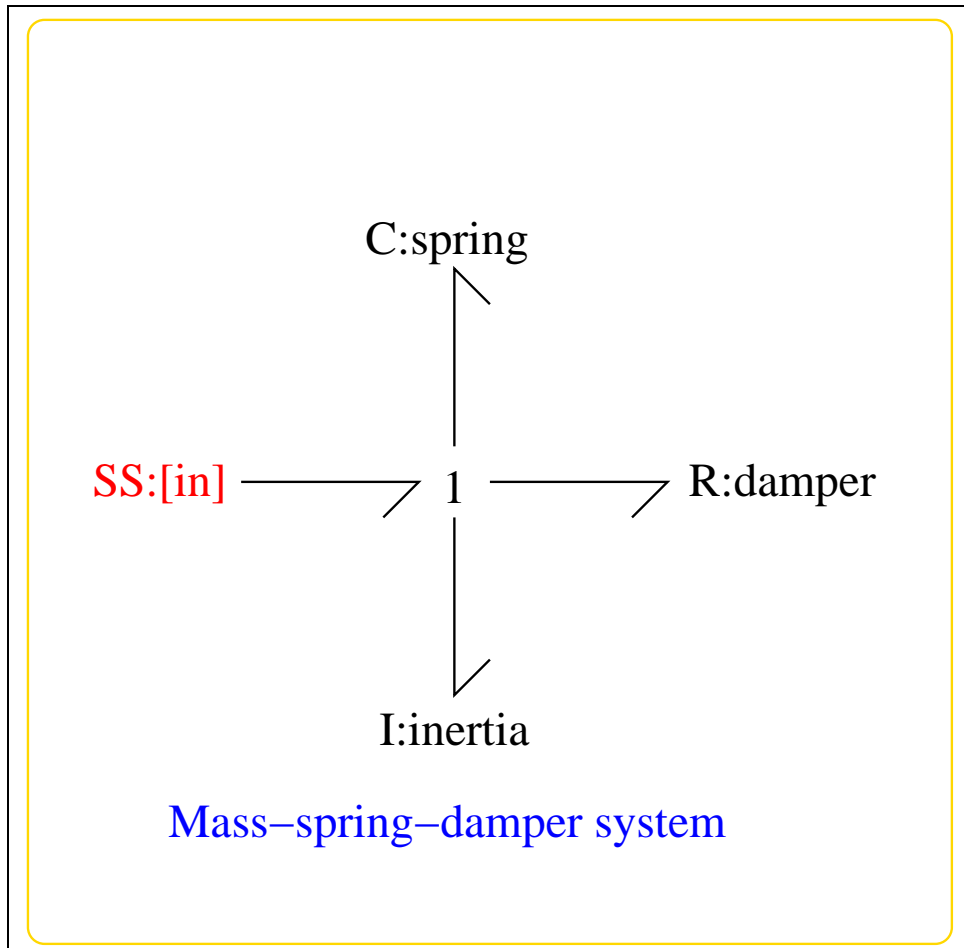
10.1.5 msdFigure 10.4: System **msd**: acausal bond graph

The acausal bond graph of system **msd** is displayed in Figure 10.4 (on page 87) and its label file is listed in Section 10.1.5 (on page 88). The subsystems are listed in Section 10.1.5 (on page 89).

msd is a simple Mass-Spring-Damper system with collocated force and velocity.

It is set up to provide a specification system for each link of the two-link maipulator. This is appropriate because

- it has compatible physical behaviour with the system itself,
- it specifies two decoupled systems,
- it has linear behaviour and

- it has a simple performance interpretation in terms of system rise-time and overshoot.

Summary information

System msd::Simple mass-spring damper ;Detailed description here;

Interface information:

This component has no ALIAS declarations

Variable declarations:

This component has no PAR declarations

Units declarations:

This component has no UNITS declarations

The label file: msd_lbl.txt

```
%SUMMARY msd: Simple mass-spring damper
%DESCRIPTION <Detailed description here>
%% Label file for system msd (msd_lbl.txt)
```

```
% %%%%%%%%%%%%%%%%%%%%%%%%%%%%%%%%%%%%%%%%%%%%%%%%%%%%%%%%%%%%%%%%%%%%%%%%%
% %% Version control history
% %%%%%%%%%%%%%%%%%%%%%%%%%%%%%%%%%%%%%%%%%%%%%%%%%%%%%%%%%%%%%%%%%%%%%%%%%
% %% $Id: msd_lbl.txt,v 1.1 2000/12/28 17:56:50 peterg Exp $
% %% $Log: msd_lbl.txt,v $
% %% Revision 1.1 2000/12/28 17:56:50 peterg
% %% To RCS
% %%
% %%%%%%%%%%%%%%%%%%%%%%%%%%%%%%%%%%%%%%%%%%%%%%%%%%%%%%%%%%%%%%%%%%%%%%%%%
```

```
%% Each line should be of one of the following forms:
% a comment (ie starting with %)
% Component-name CR_name arg1,arg2,..argn
% blank
```

```
% Component type C
spring lin state,k_s

% Component type I
inertia lin flow,m_s

% Component type R
damper lin flow,d_s

% Component type SS
[in] SS external,external
```

Subsystems

No subsystems.

10.1.6 twolink

The acausal bond graph of system **twolink** is displayed in Figure 10.5 (on page 90) and its label file is listed in Section 10.1.6 (on page 89). The subsystems are listed in Section 10.1.6 (on page 92).

This is a heirachical version of the example from Section 10.5 of "Metamodelling". It uses two compound components: **ROD** and **GRAV**. **ROD** is essentially as described in Figure 10.2 **GRAV** represents gravity by a vertical acceleration as in Section 10.9 of "Metamodelling"

Summary information

System twolink::two-link manipulator from Section 10.5 of "Metamodelling" This is a heirachical version of the example from Section 10.5 of "Metamodelling". It uses two compound components: **ROD** and **GRAV**. **ROD** is essentially as described in Figure 10.2 **GRAV** represents gravity by a vertical acceleration as in Section 10.9 of "Metamodelling"

Interface information:

This component has no ALIAS declarations

Variable declarations:

This component has no PAR declarations

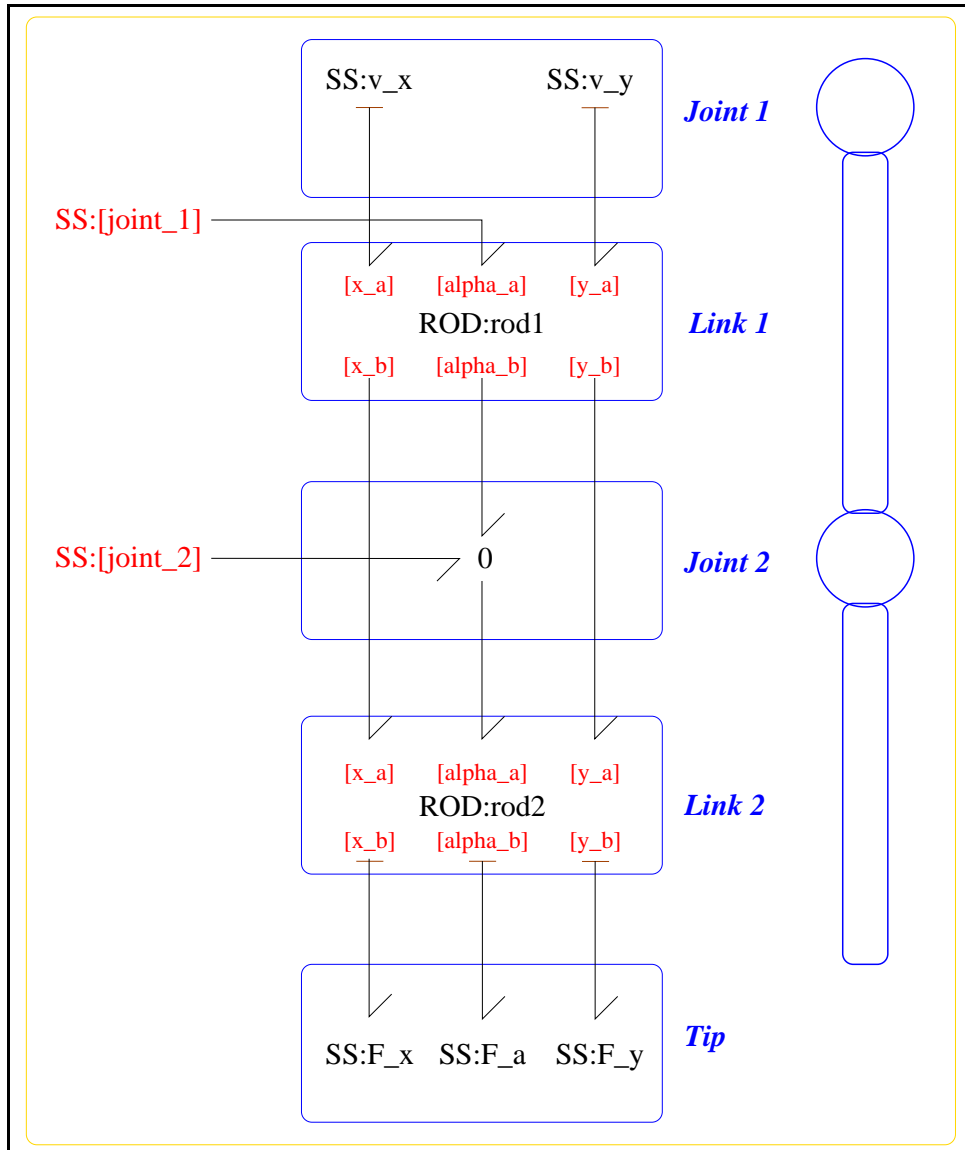

Figure 10.5: System **twolink**: acausal bond graph

Units declarations:

This component has no UNITS declarations

The label file: twolink_lbl.txt

```
%SUMMARY twolink: two-link manipulator from Section 10.5 of "Metamodelling"
%DESCRIPTION This is a heirachical version of the
%DESCRIPTION example from Section 10.5 of "Metamodelling".
%DESCRIPTION It uses two compound components: ROD and GRA
%DESCRIPTION ROD is essentially as described in Figure 10.2
%DESCRIPTION GRAV represents gravity by a vertical acceleration
%DESCRIPTION as in Section 10.9 of "Metamodelling"
```

```
%% Label (twolink_lbl.txt)
```

```
% %%%%%%%%%%%%%%%%%%%%%%%%%%%%%%%%%%%%%%%%%%%%%%%%%%%%%%%%%%
% %% Version control history
% %%%%%%%%%%%%%%%%%%%%%%%%%%%%%%%%%%%%%%%%%%%%%%%%%%%%%%%%%%
% %% $Id: twolink_lbl.txt,v 1.1 2000/12/28 17:56:50 peterg Exp $
% %% $Log: twolink_lbl.txt,v $
% %% Revision 1.1 2000/12/28 17:56:50 peterg
% %% To RCS
% %%
% %% Revision 1.2 1996/12/05 12:39:49 peterg
% %% Documentation
% %%
% %% Revision 1.1 1996/12/05 12:17:15 peterg
% %% Initial revision
% %%
% %% Revision 1.1 1996/11/14 10:48:42 peterg
% %% Initial revision
% %%
% %%%%%%%%%%%%%%%%%%%%%%%%%%%%%%%%%%%%%%%%%%%%%%%%%%%%%%%%%%
```

```
%% Each line should be of one of the following forms:
% a comment (ie starting with %)
% Component-name CR_name arg1,arg2,..argn
% blank
```

```

%Rod parameters - identical rods
rod1 none l;l;j_s;m_s
rod2 none l;l;j_s;m_s

%Zero velocity sources
v_x SS      internal,0
v_y SS      internal,0

%Zero force/torque sources
F_x SS      0,internal
F_a SS      0,internal
F_y SS      0,internal

%Torque at joints
%f_a1 SS     external,external
%f_a2 SS     external,external

%Gravity
%g

```

Subsystems

- ROD: rigid rod in two dimensions (2)
 - INTF: flow integrator (1)

10.2 iTwoLink_struct.tex

MTT command:

```
mtt iTwoLink_struct.tex
```

List of inputs for system iTwoLink			
	Component	System	Repetition
1	t1s	iTwoLink_t1s	1
2	t2s	iTwoLink_t2s	1

List of nonstates for system iTwoLink			
	Component	System	Repetition
1	J	iTwoLink_syst_rod1_J	1
2	m_x	iTwoLink_syst_rod1_m_x	1

List of nonstates for system iTwoLink (continued)			
	Component	System	Repetition
3	m_y	iTwoLink__syst__rod1__m_y	1
4	J	iTwoLink__syst__rod2__J	1
5	m_x	iTwoLink__syst__rod2__m_x	1
6	m_y	iTwoLink__syst__rod2__m_y	1

List of outputs for system iTwoLink			
	Component	System	Repetition
1	t1	iTwoLink__t1	1
2	t2	iTwoLink__t2	1
3	t1s	iTwoLink__t1s	1
4	t2s	iTwoLink__t2s	1

List of states for system iTwoLink			
	Component	System	Repetition
1	spring	iTwoLink__spec1__spring	1
2	inertia	iTwoLink__spec1__inertia	1
3	spring	iTwoLink__spec2__spring	1
4	inertia	iTwoLink__spec2__inertia	1
5	mttC	iTwoLink__syst__rod1__th__mttC	1
6	mttC	iTwoLink__syst__rod2__th__mttC	1

10.3 iTwoLink_simp.r

MTT command:

```
mtt iTwoLink simp r
```

10.4 iTwoLink_dae.tex

MTT command:

```
mtt iTwoLink dae tex
```

$$\begin{aligned}
\dot{x}_1 &= \frac{x_2}{m_s} \\
\dot{x}_2 &= \frac{(-d_s x_2 - k_s m_s x_1 + m_s u_1)}{m_s} \\
\dot{x}_3 &= \frac{x_4}{m_s} \\
\dot{x}_4 &= \frac{(-d_s x_4 - k_s m_s x_3 + m_s u_2)}{m_s} \\
\dot{x}_5 &= \frac{x_2}{m_s} \\
\dot{x}_6 &= \frac{(x_2 + x_4)}{m_s}
\end{aligned} \tag{10.1}$$

$$\begin{aligned}
z_1 &= \frac{(j_s x_2)}{m_s} \\
z_2 &= -\cos(x_5) l x_2 \\
z_3 &= \sin(x_5) l x_2 \\
z_4 &= \frac{(j_s (x_2 + x_4))}{m_s} \\
z_5 &= l(-2 \cos(x_5) x_2 - \cos(x_6) x_2 - \cos(x_6) x_4) \\
z_6 &= l(2 \sin(x_5) x_2 + \sin(x_6) x_2 + \sin(x_6) x_4)
\end{aligned} \tag{10.2}$$

$$\begin{aligned}
y_1 &= -\cos(x_5) l \dot{z}_2 - 2 \cos(x_5) l \dot{z}_5 - \cos(x_6) l \dot{z}_5 + \sin(x_5) l \dot{z}_3 + 2 \sin(x_5) l \dot{z}_6 + \sin(x_6) l \dot{z}_6 + \dot{z}_1 + \dot{z}_4 \\
y_2 &= -\cos(x_6) l \dot{z}_5 + \sin(x_6) l \dot{z}_6 + \dot{z}_4 \\
y_3 &= \frac{x_2}{m_s} \\
y_4 &= \frac{x_4}{m_s}
\end{aligned} \tag{10.3}$$

10.5 iTwoLink_ode.tex

MTT command:

```
mtt iTwoLink_ode.tex
```

Tue Aug 19 15:04:36 BST 2003

Page 97.

$$\begin{aligned}
\dot{x}_1 &= \frac{x_2}{m_s} \\
\dot{x}_2 &= \frac{(-d_s x_2 - k_s m_s x_1 + m_s u_1)}{m_s} \\
\dot{x}_3 &= \frac{x_4}{m_s} \\
\dot{x}_4 &= \frac{(-d_s x_4 - k_s m_s x_3 + m_s u_2)}{m_s} \\
\dot{x}_5 &= \frac{x_2}{m_s} \\
\dot{x}_6 &= \frac{(x_2 + x_4)}{m_s}
\end{aligned} \tag{10.4}$$

$$y_1 = \frac{(-4 \cos(x_5 - x_6) d_s l^2 m_s x_2 - 2 \cos(x_5 - x_6) d_s l^2 m_s x_4 - 4 \cos(x_5 - x_6) k_s l^2 m_s^2 x_1 - 2 \cos(x_5 - x_6) l^2 m_s^2 u_1 - 2 \sin(x_5 - x_6) l^2 m_s^2 u_2)}{m_s}$$

$$y_2 = \frac{(-2 \cos(x_5 - x_6) d_s l^2 m_s x_2 - 2 \cos(x_5 - x_6) k_s l^2 m_s^2 x_1 + 2 \cos(x_5 - x_6) l^2 m_s^2 u_1 - 2 \sin(x_5 - x_6) l^2 m_s^2 u_2)}{m_s}$$

$$y_3 = \frac{x_2}{m_s}$$

$$y_4 = \frac{x_4}{m_s}$$

(10.5)

10.6 iTwoLink_sspar.r

MTT command:

```
mtt iTwoLink sspar r
```

10.7 iTwoLink_sm.tex

MTT command:

```
mtt iTwoLink sm tex
```

$$A = \begin{pmatrix} 0 & \frac{1}{m_s} & 0 & 0 & 0 & 0 \\ -k_s & \frac{(-d_s)}{m_s} & 0 & 0 & 0 & 0 \\ 0 & 0 & 0 & \frac{1}{m_s} & 0 & 0 \\ 0 & 0 & -k_s & \frac{(-d_s)}{m_s} & 0 & 0 \\ 0 & \frac{1}{m_s} & 0 & 0 & 0 & 0 \\ 0 & \frac{1}{m_s} & 0 & \frac{1}{m_s} & 0 & 0 \end{pmatrix} \quad (10.6)$$

$$B = \begin{pmatrix} 0 & 0 \\ 1 & 0 \\ 0 & 0 \\ 0 & 1 \\ 0 & 0 \\ 0 & 0 \end{pmatrix} \quad (10.7)$$

$$C = \begin{pmatrix} \frac{(2k_s(-j_s-5l^2m_s))}{m_s} & \frac{(2d_s(-j_s-5l^2m_s))}{m_s^2} & \frac{(k_s(-j_s-3l^2m_s))}{m_s} & \frac{(d_s(-j_s-3l^2m_s))}{m_s^2} & 0 & 0 \\ \frac{(k_s(-j_s-3l^2m_s))}{m_s} & \frac{(d_s(-j_s-3l^2m_s))}{m_s^2} & \frac{(-k_s(j_s+l^2m_s))}{m_s} & \frac{(-d_s(j_s+l^2m_s))}{m_s^2} & 0 & 0 \\ 0 & \frac{1}{m_s} & 0 & 0 & 0 & 0 \\ 0 & 0 & 0 & \frac{1}{m_s} & 0 & 0 \end{pmatrix} \quad (10.8)$$

$$D = \begin{pmatrix} \frac{(2(j_s+5l^2m_s))}{m_s} & \frac{(j_s+3l^2m_s)}{m_s} \\ \frac{(j_s+3l^2m_s)}{m_s} & \frac{(j_s+l^2m_s)}{m_s} \end{pmatrix} \quad (10.9)$$

10.8 iTwoLink_tf.tex

MTT command:

```
mtt iTwoLink tf tex
```

$$G = \begin{pmatrix} \frac{(2s^2(j_s+5l^2m_s))}{(d_s s+k_s+m_s s^2)} & \frac{(s^2(j_s+3l^2m_s))}{(d_s s+k_s+m_s s^2)} \\ \frac{(s^2(j_s+3l^2m_s))}{(d_s s+k_s+m_s s^2)} & \frac{(s^2(j_s+l^2m_s))}{(d_s s+k_s+m_s s^2)} \\ \frac{s}{(d_s s+k_s+m_s s^2)} & 0 \\ 0 & \frac{s}{(d_s s+k_s+m_s s^2)} \end{pmatrix} \quad (10.10)$$

10.9 iTwoLink_numpar.txt

MTT command:

```
mtt iTwoLink numpar txt
```

```
# Numerical parameter file (iTwoLink_numpar.txt)
# Generated by MTT at Mon Nov 17 10:40:34 GMT 1997
```

```
# %%%%%%%%%%%%%%%%%%%%%%%%%%%%%%%%%%%%%%%%%%%%%%%%%%%%%%%%%%%%%%%%%%%%%%%%%%
# %% Version control history
# %%%%%%%%%%%%%%%%%%%%%%%%%%%%%%%%%%%%%%%%%%%%%%%%%%%%%%%%%%%%%%%%%%%%%%%%%%
# %% $Id: iTwoLink_numpar.txt,v 1.1 2000/05/20 16:52:06 peterg Exp
# %% $Log: iTwoLink_numpar.txt,v $
# %% Revision 1.1 2000/05/20 16:52:06 peterg
# %% Initial revision
# %%
# %%%%%%%%%%%%%%%%%%%%%%%%%%%%%%%%%%%%%%%%%%%%%%%%%%%%%%%%%%%%%%%%%%%%%%%%%%
```

```
# Parameters
```

```
d_s = 1.0; # Parameter d_s for msd
k_s = 1.0; # Parameter k_s for msd
m_s = 1.0; # Parameter m_s for msd
j_s = 1.0; # Parameter j_s for twolink
l = 1.0; # Parameter l for twolink
m_s = 1.0; # Parameter m_s for twolink
```

10.10 iTwoLink_input.txt

MTT command:

```
mtt iTwoLink input txt
```

```
# Numerical parameter file (iTwoLink_input.txt)
# Generated by MTT at Mon Nov 17 10:40:37 GMT 1997
```

```
# %%%%%%%%%%%%%%%%%%%%%%%%%%%%%%%%%%%%%%%%%%%%%%%%%%%%%%%%%%%%%%%%%%%%%%%%%%
# %% Version control history
# %%%%%%%%%%%%%%%%%%%%%%%%%%%%%%%%%%%%%%%%%%%%%%%%%%%%%%%%%%%%%%%%%%%%%%%%%%
# %% $Id: iTwoLink_input.txt,v 1.1 2000/12/28 17:56:50 peterg Exp
```

```

# %% $Log: iTwoLink_input.txt,v $
# %% Revision 1.1 2000/12/28 17:56:50 peterg
# %% To RCS
# %%
# %%%%%%%%%%%%%%%%%%%%%%%%%%%%%%%%%%%%%%%%%%%%%%%%%%%%%%%%%%%%%%%%%%%%%%%%%%

# Set the inputs
## Removed by MTT on Mon Aug 18 18:15:41 BST 2003: u(1) =
1.0 - 2.0*(t>5.0) + 2.0*(t>15.0); # t1s input torque
## Removed by MTT on Mon Aug 18 18:15:41 BST 2003: u(2) =
1.0 - 2.0*(t>5.0) + (t>15.0); # t2s input torque
itwolink__t1s = 1.0 - 2.0*(t>5.0) + 2.0*(t>15.0); # t1s input torque
itwolink__t2s = 1.0 - 2.0*(t>5.0) + (t>15.0); # t2s input torque

```

10.11 iTwoLink_odeso.ps (*-iTwoLink_t1*)

MTT command:

```
mtt iTwoLink odeso ps 'iTwoLink__t1'
```

This representation is given as Figure 10.6 (on page 99).

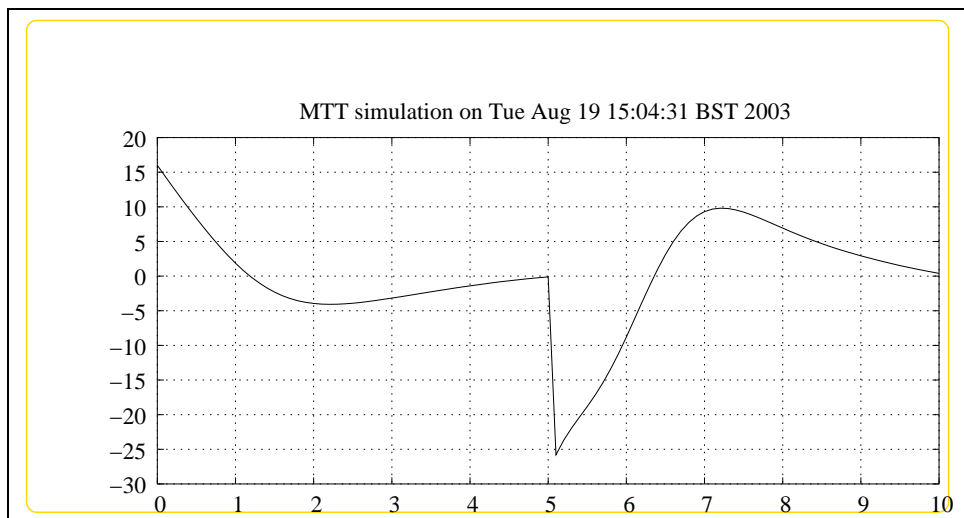

10.12 **iTwoLink_odeso.ps (-iTwoLink_t2)**

MTT command:

```
mtt iTwoLink odeso ps 'iTwoLink__t2'
```

This representation is given as Figure 10.7 (on page 100).

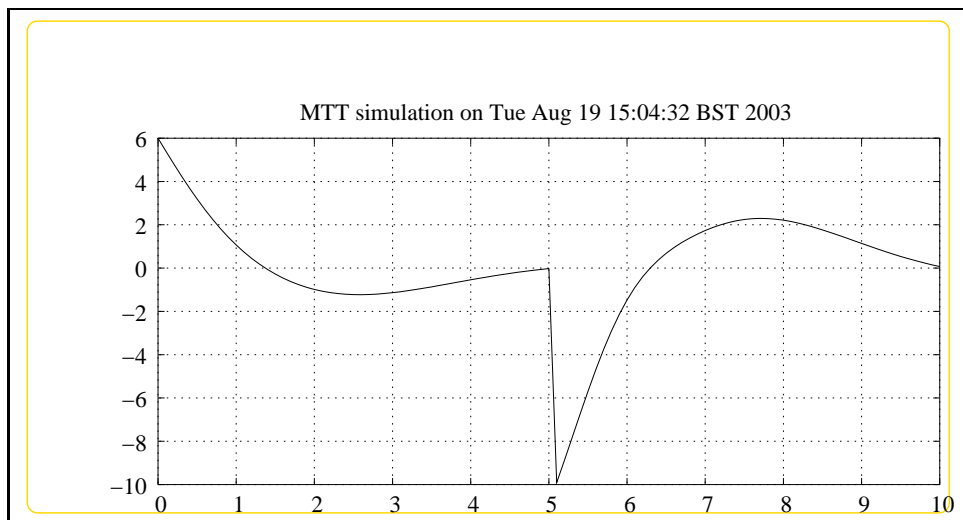

10.13 **iTwoLink_odeso.ps (-iTwoLink_t1s)**

MTT command:

```
mtt iTwoLink odeso ps 'iTwoLink__t1s'
```

This representation is given as Figure 10.8 (on page 101).

10.14 **iTwoLink_odeso.ps (-iTwoLink_t1s:iTwoLink_t1)**

MTT command:

```
mtt iTwoLink odeso ps 'iTwoLink__t1s:iTwoLink__t1'
```

This representation is given as Figure 10.9 (on page 101).

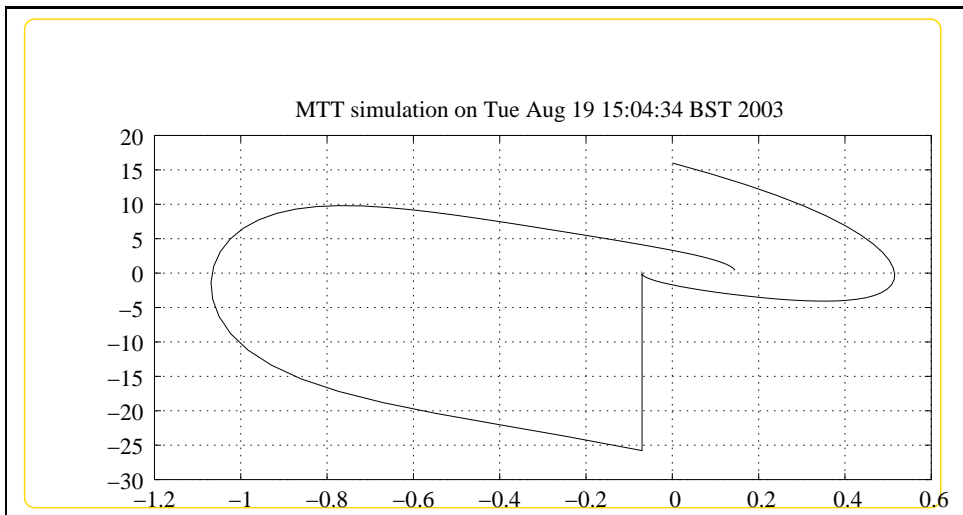
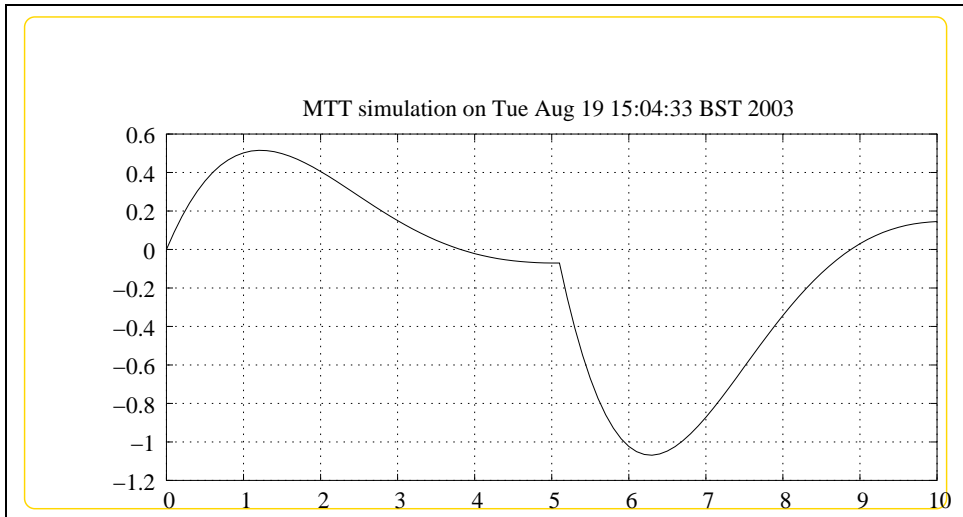

10.15 **iTwoLink_odeso.ps** (**-iTwoLink_t2s:iTwoLink_t2**)

MTT command:

```
mtt iTwoLink odeso ps 'iTwoLink__t2s:iTwoLink__t2'
```

This representation is given as Figure 10.10 (on page 102).

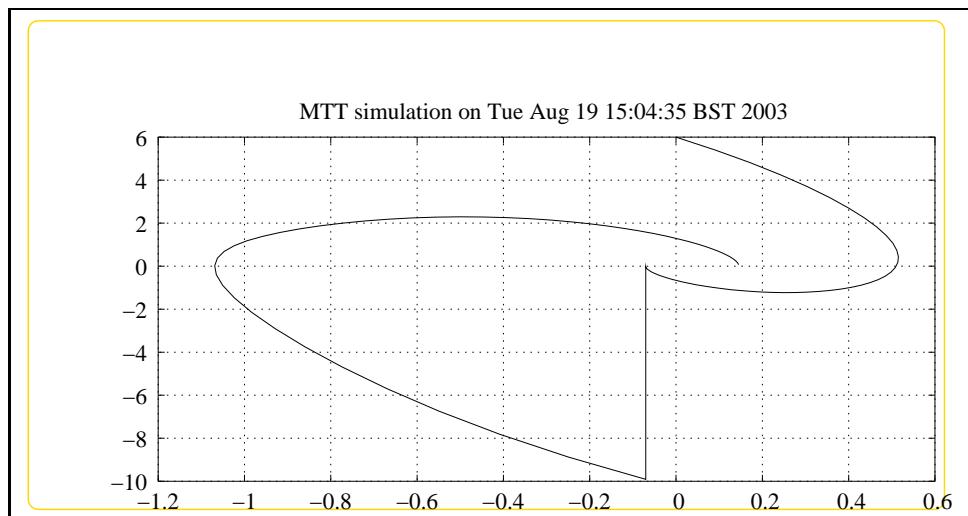

Index

- INTF** – abg, 82
- INTF** – lbl, 82
- INTF** – subsystems, 84
 - NMP** – abg, 21
 - NMP** – lbl, 22
 - NMP** – lmfr, 27
 - NMP** – lpfr, 27
 - NMP** – ode, 24
 - NMP** – sm, 25
 - NMP** – sro, 25
 - NMP** – struc, 24
- NMP** – subsystems, 24
 - NMP** – tf, 25
- ROD** – abg, 84
- ROD** – lbl, 85
- ROD** – subsystems, 86
- iMacroMicro** – abg, 9
- iMacroMicro** – cbg, 11
- iMacroMicro** – dae, 12
- iMacroMicro** – dm, 13
- iMacroMicro** – lbl, 10
- iMacroMicro** – lmfr, 15
- iMacroMicro** – lpfr, 15
- iMacroMicro** – numpar, 15
- iMacroMicro** – odeso, 17
- iMacroMicro** – sro, 15
- iMacroMicro** – struc, 12
- iMacroMicro** – subsystems, 11
 - iMacroMicro** – tf, 14
 - iNMP** – abg, 29
 - iNMP** – dm, 33
 - iNMP** – lbl, 30
 - iNMP** – lmfr, 34
 - iNMP** – lpfr, 34
 - iNMP** – ode, 32
 - iNMP** – struc, 32
- iNMP** – subsystems, 32
 - iNMP** – tf, 34
- iRC2c** – abg, 39
- iRC2c** – dae, 41
- iRC2c** – dm, 42
- iRC2c** – lbl, 39
- iRC2c** – struc, 41
- iRC2c** – subsystems, 41
 - iRC2c** – tf, 42
- iRC2n** – abg, 43
- iRC2n** – dae, 45
- iRC2n** – dm, 46
- iRC2n** – lbl, 43
- iRC2n** – struc, 45
- iRC2n** – subsystems, 45
 - iRC2n** – tf, 46
- iTanks** – abg, 71
- iTanks** – cbg, 74
- iTanks** – dm, 75
- iTanks** – lbl, 72
- iTanks** – lmfr, 76
- iTanks** – lpfr, 76
- iTanks** – struc, 74
- iTanks** – subsystems, 73
 - iTanks** – tf, 76
- iTwoLink** – abg, 79
- iTwoLink** – dae, 94
- iTwoLink** – input, 98
- iTwoLink** – lbl, 80
- iTwoLink** – numpar, 98

- iTwoLink** – ode, 95
- iTwoLink** – odeso, 99, 100
- iTwoLink** – simp, 94
- iTwoLink** – sm, 96
- iTwoLink** – sspar, 96
- iTwoLink** – struc, 92
- iTwoLink** – subsystems, 82
 - iTwoLink** – tf, 97
 - msd** – abg, 87
 - msd** – lbl, 88
 - msd** – subsystems, 89
 - saRC2c** – abg, 47
 - saRC2c** – dae, 50
 - saRC2c** – dm, 50
 - saRC2c** – lbl, 48
 - saRC2c** – lmfr, 51
 - saRC2c** – odeso, 51
 - saRC2c** – struc, 49
 - saRC2c** – subsystems, 49
 - saRC2c** – tf, 51
 - szRC2c** – abg, 53
 - szRC2c** – dae, 56
 - szRC2c** – dm, 57
 - szRC2c** – lbl, 54
 - szRC2c** – lmfr, 58
 - szRC2c** – struc, 55
 - szRC2c** – subsystems, 55
 - szRC2c** – tf, 57
 - szRC2n** – abg, 61
 - szRC2n** – dae, 64
 - szRC2n** – dm, 65
 - szRC2n** – lbl, 62
 - szRC2n** – lmfr, 66
 - szRC2n** – odeso, 66
 - szRC2n** – struc, 63
- szRC2n** – subsystems, 63
 - szRC2n** – tf, 66
- twolink** – abg, 89
- twolink** – lbl, 89
- twolink** – subsystems, 92
- zRC2c** – odeso, 58